

INFORMAZIONI TECNICHE

TECHNICAL INFORMATION

INFORMATIONS TECHNIQUES

TECHNISCHE INFORMATIE

INFORMACIÓN TÉCNICA

EUROPEAN FORMAT

FISSAGGI D - FIXINGS D - FIXATIONS D - BEFESTIGUNGEN D - BEVESTIGING D

- ART.
FIX.011.000D.xx (Ø25)
FIX.012.000D.xx (Ø30)
FIX.013.000D.xx (Ø35)
FIX.014.000D.xx (Ø20)
FIX.016.000D.xx (Ø40)

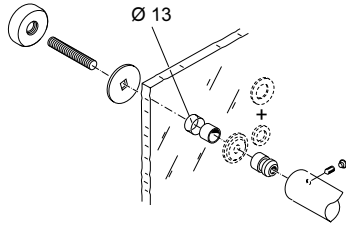

- SINGOLO PASSANTE PER VETRO
- SINGLE THROUGH FITTING FOR GLASS
- FIXATION SIMPLE TRAVERSANT POUR VERRE
- BEFESTIGUNG EINSEITIG DURCHGEHEND FÜR GLASTÜREN
- ENKELE DOORGAANDE BEVESTIGING VOOR GLAS

- ART.
FIX.110.000D.xx

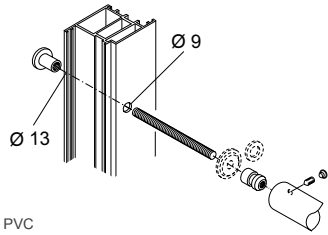

- SINGOLO PASSANTE PER LEGNO, ALLUMINIO, PVC
- SINGLE THROUGH FITTING FOR WOOD, ALUMINIUM, PVC
- FIXATION SIMPLE TRAVERSANT POUR BOIS, ALUMINIUM, PVC
- BEFESTIGUNG EINSEITIG DURCHGEHEND FÜR ALLE TÜRARTEN
- ENKELE DOORGAANDE BEVESTIGING VOOR HOUT, ALUMINIUM EN PVC

- ART.
FIX.210.000D.B2

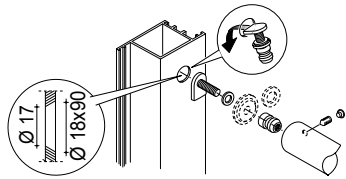

- SINGOLO NON PASSANTE PER PROFILO TUBOLARE
- SINGLE NON THROUGH FITTING FOR TUBULAR PROFILE
- FIXATION SIMPLE NON TRAVERSANT POUR PROFIL TUBULAIRE
- BEFESTIGUNG EINSEITIG UNSICHTBAR FÜR 1-KAMMER KUNSTSTOFFTÜREN
- ENKELE NIET-DOORGAANDE BEVESTIGING VOOR PROFIELEN

- ART.
FIX.310.000D.B2

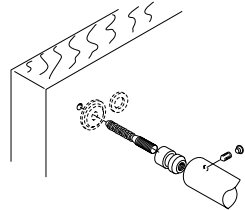

- SINGOLO NON PASSANTE PER LEGNO
- SINGLE NON THROUGH FITTING FOR WOOD
- FIXATION SIMPLE NON TRAVERSANT POUR BOIS
- BEFESTIGUNG EINSEITIG UNSICHTBAR FÜR HOLZTÜREN
- ENKELE NIET-DOORGAANDE BEVESTIGING VOOR HOUT

- ART.
FIX.410.000D.B2
A= 33 mm
FIX.410.00DL.B2
A= 50 mm

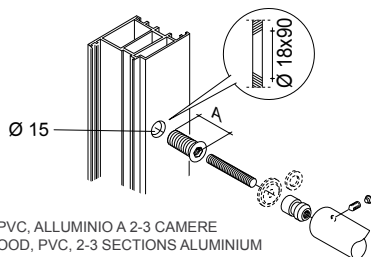

- SINGOLO NON PASSANTE PER LEGNO, PVC, ALLUMINIO A 2-3 CAMERE
- SINGLE NON THROUGH FITTING FOR WOOD, PVC, 2-3 SECTIONS ALUMINIUM
- FIXATION SIMPLE NON TRAVERSANT POUR BOIS, PVC, ALUMINIUM 2-3 SECTIONS
- EINZELBEFESTIGUNG FÜR 3 KAMMER - METALLTÜREN
- ENKELE NIET-DOORGAANDE BEVESTIGING VOOR HOUT, PVC EN ALUMINIUM PROFIELEN MET 2-3 KAMERS

- ART.
FIX.510.000D.B2
A= 33 mm
FIX.510.00DL.B2
A= 50 mm

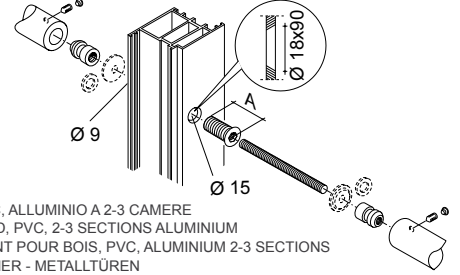

- CONTRAPPOSTO PER LEGNO, PVC, ALLUMINIO A 2-3 CAMERE
- BACK TO BACK FITTING FOR WOOD, PVC, 2-3 SECTIONS ALUMINIUM
- FIXATION SIMPLE NON TRAVERSANT POUR BOIS, PVC, ALUMINIUM 2-3 SECTIONS
- EINZELBEFESTIGUNG FÜR 3 KAMMER - METALLTÜREN
- ENKELE NIET-DOORGAANDE BEVESTIGING VOOR HOUT, PVC EN ALUMINIUM PROFIELEN MET 2-3 KAMERS

- ART.
FIX.610.000D.B2

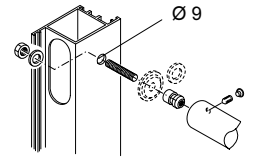

- SINGOLO NON PASSANTE PER PROFILO TUBOLARE
- SINGLE NON THROUGH FITTING FOR TUBULAR PROFILE
- FIXATION SIMPLE NON TRAVERSANT POUR PROFIL TUBULAIRE
- BEFESTIGUNG EINSEITIG UNSICHTBAR FÜR 1-KAMMER KUNSTSTOFFTÜREN
- ENKELE NIET-DOORGAANDE BEVESTIGING VOOR PROFIELEN

- ART.
FIX.710.000D.B2

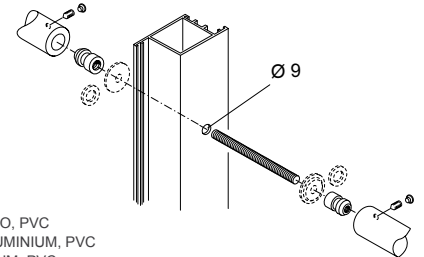

- CONTRAPPOSTO PER LEGNO, ALLUMINIO, PVC
- BACK TO BACK FITTING FOR WOOD, ALUMINIUM, PVC
- FIXATION DOUBLE POUR BOIS, ALUMINIUM, PVC
- BEIDSEITIGE BEFESTIGUNG FÜR ALLE TÜRARTEN
- PAARSGEWIJZE BEVESTIGING VOOR HOUT, ALUMINIUM EN PVC

- ART.
FIX.810.000D.B2

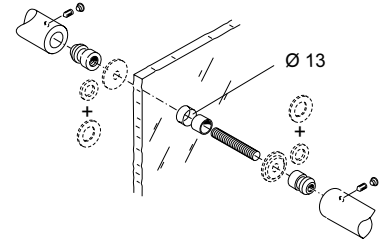

- CONTRAPPOSTO PER VETRO
- BACK TO BACK FITTING FOR GLASS
- FIXATION DOUBLE POUR VERRE
- BEIDSEITIGE BEFESTIGUNG FÜR GLASTÜREN
- PAARSGEWIJZE BEVESTIGING VOOR GLAS

- ART.
FIX.911.000D.xx (Ø25) 50
FIX.912.000D.xx (Ø30) 60
FIX.913.000D.xx (Ø35) 60
FIX.914.000D.xx (Ø20) 50

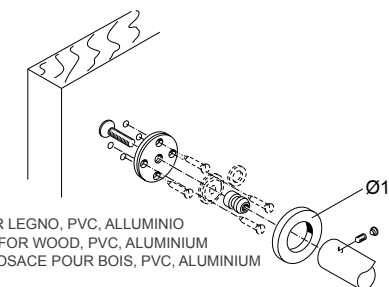

- SINGOLO NON PASSANTE CON ROSETTA PER LEGNO, PVC, ALLUMINIO
- SINGLE NON THROUGH FITTING WITH ROSE FOR WOOD, PVC, ALUMINIUM
- FIXATION SIMPLE NON TRAVERSANT AVEC ROSACE POUR BOIS, PVC, ALUMINIUM
- EINZELBEFESTIGUNG MIT ROSETTEN
- ENKELE NIET-DOORGAANDE ROZEBEVESTIGING VOOR HOUT, PVC EN ALUMINIUM

FISSAGGI I - FIXINGS I - FIXATIONS I - BEFESTIGUNGEN I - BEVESTIGING I

ART.
FIX.025.000I.xx

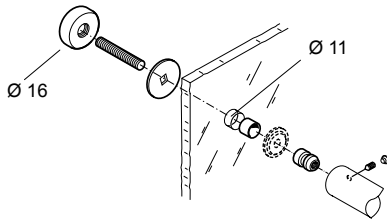

- SINGOLO PASSANTE PER VETRO
- SINGLE THROUGH FITTING FOR GLASS
- FIXATION SIMPLE TRAVERSANT POUR VERRE
- BEFESTIGUNG EINSEITIG DURCHGEHEND FÜR GLASTÜREN
- ENKELE DOORGAANDE BEVESTIGING VOOR GLAS

ART.
FIX.120.000I.xx

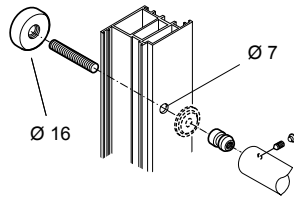

- SINGOLO PASSANTE PER LEGNO, ALLUMINIO, PVC
- SINGLE THROUGH FITTING FOR WOOD, ALUMINIUM, PVC
- FIXATION SIMPLE TRAVERSANT POUR BOIS, ALUMINIUM, PVC
- BEFESTIGUNG EINSEITIG DURCHGEHEND FÜR ALLE TÜRARTEN
- ENKELE DOORGAANDE BEVESTIGING VOOR HOUT, ALUMINIUM EN PVC

ART.
FIX.220.000I.B2

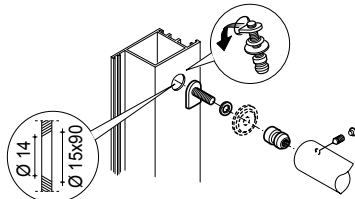

- SINGOLO NON PASSANTE PER PROFILO TUBOLARE
- SINGLE NON THROUGH FITTING FOR TUBULAR PROFILE
- FIXATION SIMPLE NON TRAVERSANT POUR PROFIL TUBULAIRE
- BEFESTIGUNG EINSEITIG UNSICHTBAR FÜR 1-KAMMER KUNSTSTOFFTÜREN
- ENKELE NIET-DOORGAANDE BEVESTIGING VOOR PROFIELN

ART.
FIX.320.000I.B2

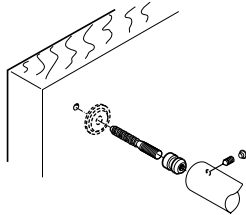

- SINGOLO NON PASSANTE PER LEGNO
- SINGLE NON THROUGH FITTING FOR WOOD
- FIXATION SIMPLE NON TRAVERSANT POUR BOIS
- BEFESTIGUNG EINSEITIG UNSICHTBAR FÜR HOLZTÜREN
- ENKELE NIET-DOORGAANDE BEVESTIGING VOOR HOUT

ART.
FIX.420.000I.B2
A= 33 mm
FIX.420.00IL.B2
A= 50 mm

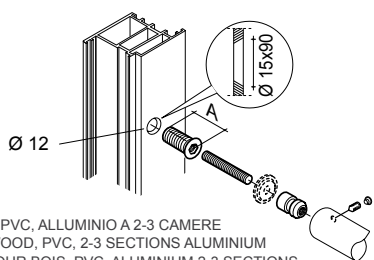

- SINGOLO NON PASSANTE PER LEGNO, PVC, ALLUMINIO A 2-3 CAMERE
- SINGLE NON THROUGH FITTING FOR WOOD, PVC, 2-3 SECTIONS ALUMINIUM
- FIXATION SIMPLE NON TRAVERSANT POUR BOIS, PVC, ALUMINIUM 2-3 SECTIONS
- EINZELBEFESTIGUNG FÜR 3 KAMMER - METALLTÜREN
- ENKELE NIET-DOORGAANDE BEVESTIGING VOOR HOUT, PVC EN ALUMINIUM PROFIELN MET 2-3 KAMERS

ART.
FIX.520.000I.B2
A= 33 mm
FIX.520.00IL.B2
A= 50 mm

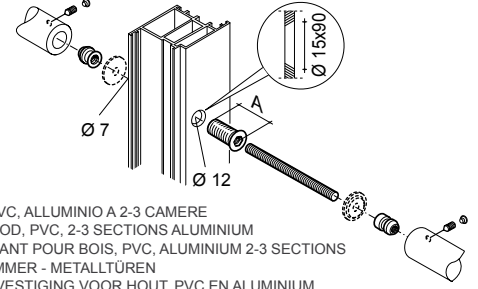

- CONTRAPPOSTO PER LEGNO, PVC, ALLUMINIO A 2-3 CAMERE
- BACK TO BACK FITTING FOR WOOD, PVC, 2-3 SECTIONS ALUMINIUM
- FIXATION SIMPLE NON TRAVERSANT POUR BOIS, PVC, ALUMINIUM 2-3 SECTIONS
- EINZELBEFESTIGUNG FÜR 3 KAMMER - METALLTÜREN
- ENKELE NIET-DOORGAANDE BEVESTIGING VOOR HOUT, PVC EN ALUMINIUM PROFIELN MET 2-3 KAMERS

ART.
FIX.620.000I.B2

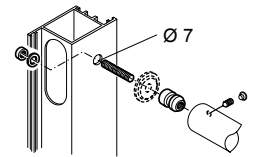

- SINGOLO NON PASSANTE PER PROFILO TUBOLARE
- SINGLE NON THROUGH FITTING FOR TUBULAR PROFILE
- FIXATION SIMPLE NON TRAVERSANT POUR PROFIL TUBULAIRE
- BEFESTIGUNG EINSEITIG UNSICHTBAR FÜR 1-KAMMER KUNSTSTOFFTÜREN
- ENKELE NIET-DOORGAANDE BEVESTIGING VOOR PROFIELN

ART.
FIX.720.000I.B2

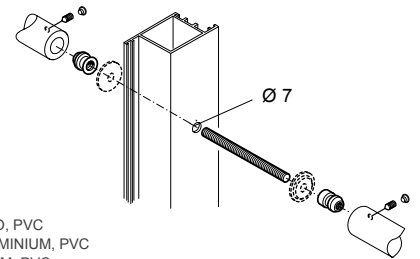

- CONTRAPPOSTO PER LEGNO, ALLUMINIO, PVC
- BACK TO BACK FITTING FOR WOOD, ALUMINIUM, PVC
- FIXATION DOUBLE POUR BOIS, ALUMINIUM, PVC
- BEIDSEITIGE BEFESTIGUNG FÜR ALLE TÜRARTEN
- PAARSGEWIJZE BEVESTIGING VOOR HOUT, ALUMINIUM EN PVC

ART.
FIX.820.000I.B2

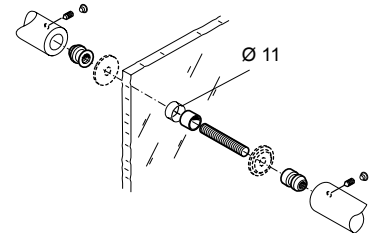

- CONTRAPPOSTO PER VETRO
- BACK TO BACK FITTING FOR GLASS
- FIXATION DOUBLE POUR VERRE
- BEIDSEITIGE BEFESTIGUNG FÜR GLASTÜREN
- PAARSGEWIJZE BEVESTIGING VOOR GLAS

ART.
FIX.925.000I.xx

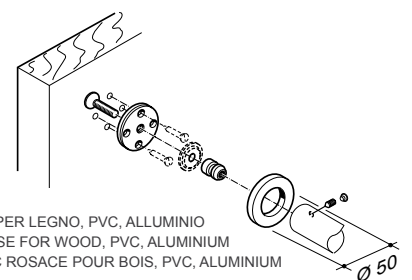

- SINGOLO NON PASSANTE CON ROSETTA PER LEGNO, PVC, ALLUMINIO
- SINGLE NON THROUGH FITTING WITH ROSE FOR WOOD, PVC, ALUMINIUM
- FIXATION SIMPLE NON TRAVERSANT AVEC ROSACE POUR BOIS, PVC, ALUMINIUM
- EINZELBEFESTIGUNG MIT ROSETTEN
- ENKELE NIET-DOORGAANDE ROZEBEVESTIGING VOOR HOUT, PVC EN ALUMINIUM

FISSAGGI D - FIXINGS D - FIXATIONS D - BEFESTIGUNGEN D - BEVESTIGING D

ART.
FIX.012.000D.10 (Ø 25 - Ø 30)
FIX.013.000D.10 (Ø 35)

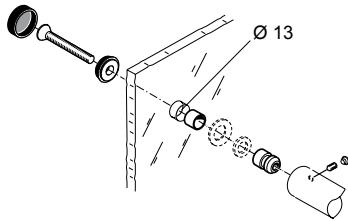

- SINGOLO PASSANTE PER VETRO
- SINGLE THROUGH FITTING FOR GLASS
- FIXATION SIMPLE TRAVERSANT POUR VERRE
- BEFESTIGUNG EINSEITIG DURCHGEHEND FÜR GLASTÜREN
- ENKELE DOORGAANDE BEVESTIGING VOOR GLAS

ART.
FIX.112.000D.10 (Ø 25 - Ø 30)
FIX.113.000D.10 (Ø 35)

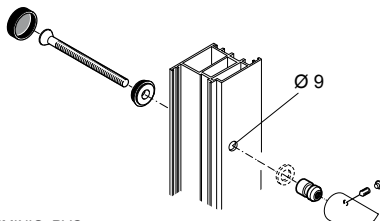

- SINGOLO PASSANTE PER LEGNO, ALLUMINIO, PVC
- SINGLE THROUGH FITTING FOR WOOD, ALUMINIUM, PVC
- FIXATION SIMPLE TRAVERSANT POUR BOIS, ALUMINIUM, PVC
- BEFESTIGUNG EINSEITIG DURCHGEHEND FÜR ALLE TÜRARTEN
- ENKELE DOORGAANDE BEVESTIGING VOOR HOUT, ALUMINIUM EN PVC

ART.
FIX.210.000D.B2

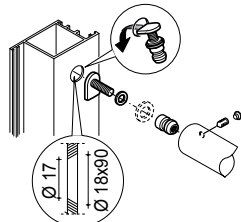

- SINGOLO NON PASSANTE PER PROFILO TUBOLARE
- SINGLE NON THROUGH FITTING FOR TUBULAR PROFILE
- FIXATION SIMPLE NON TRAVERSANT POUR PROFIL TUBULAIRE
- BEFESTIGUNG EINSEITIG UNSICHTBAR FÜR 1-KAMMER KUNSTSTOFFTÜREN
- ENKELE NIET-DOORGAANDE BEVESTIGING VOOR PROFIELEN

ART.
FIX.310.000D.B2

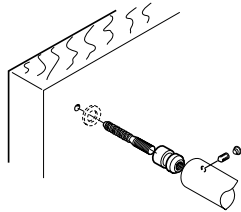

- SINGOLO NON PASSANTE PER LEGNO
- SINGLE NON THROUGH FITTING FOR WOOD
- FIXATION SIMPLE NON TRAVERSANT POUR BOIS
- BEFESTIGUNG EINSEITIG UNSICHTBAR FÜR HOLZTÜREN
- ENKELE NIET-DOORGAANDE BEVESTIGING VOOR HOUT

ART.
FIX.410.000D.B2
A= 33 mm
FIX.410.00DL.B2
A= 50 mm

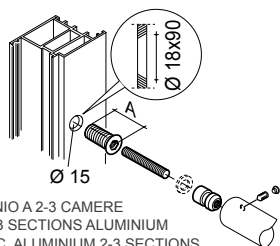

- SINGOLO NON PASSANTE PER LEGNO, PVC, ALLUMINIO A 2-3 CAMERE
- SINGLE NON THROUGH FITTING FOR WOOD, PVC, 2-3 SECTIONS ALUMINIUM
- FIXATION SIMPLE NON TRAVERSANT POUR BOIS, PVC, ALUMINIUM 2-3 SECTIONS
- EINZELBEFESTIGUNG FÜR 3 KAMMER - METALLTÜREN
- ENKELE NIET-DOORGAANDE BEVESTIGING VOOR HOUT, PVC EN ALUMINIUM PROFIELEN MET 2-3 KAMERS

ART.
FIX.510.000D.B2
A= 33 mm
FIX.510.00DL.B2
A= 50 mm

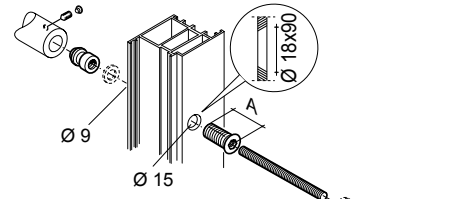

- CONTRAPPOSTO PER LEGNO, PVC, ALLUMINIO A 2-3 CAMERE
- BACK TO BACK FITTING FOR WOOD, PVC, 2-3 SECTIONS ALUMINIUM
- FIXATION SIMPLE NON TRAVERSANT POUR BOIS, PVC, ALUMINIUM 2-3 SECTIONS
- EINZELBEFESTIGUNG FÜR 3 KAMMER - METALLTÜREN
- ENKELE NIET-DOORGAANDE BEVESTIGING VOOR HOUT, PVC EN ALUMINIUM PROFIELEN MET 2-3 KAMERS

ART.
FIX.610.000D.B2

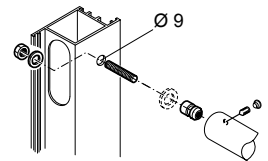

- SINGOLO NON PASSANTE PER PROFILO TUBOLARE
- SINGLE NON THROUGH FITTING FOR TUBULAR PROFILE
- FIXATION SIMPLE NON TRAVERSANT POUR PROFIL TUBULAIRE
- BEFESTIGUNG EINSEITIG UNSICHTBAR FÜR 1-KAMMER KUNSTSTOFFTÜREN
- ENKELE NIET-DOORGAANDE BEVESTIGING VOOR PROFIELEN

ART.
FIX.710.000D.B2

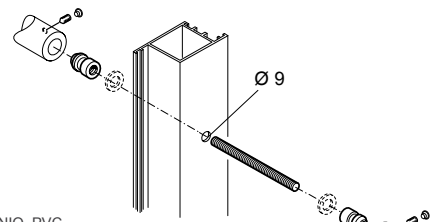

- CONTRAPPOSTO PER LEGNO, ALLUMINIO, PVC
- BACK TO BACK FITTING FOR WOOD, ALUMINIUM, PVC
- FIXATION DOUBLE POUR BOIS, ALUMINIUM, PVC
- BEIDSEITIGE BEFESTIGUNG FÜR ALLE TÜRARTEN
- PAARSGEWIJZE BEVESTIGING VOOR HOUT, ALUMINIUM EN PVC

ART.
FIX.810.000D.B2

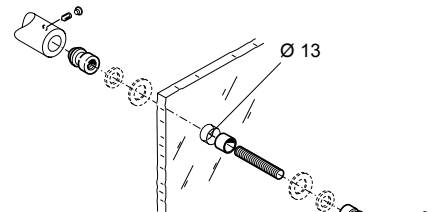

- CONTRAPPOSTO PER VETRO
- BACK TO BACK FITTING FOR GLASS
- FIXATION DOUBLE POUR VERRE
- BEIDSEITIGE BEFESTIGUNG FÜR GLASTÜREN
- PAARSGEWIJZE BEVESTIGING VOOR GLAS

ART.
FIX.912.000D.10 (Ø 30) Ø1 70
FIX.913.000D.10 (Ø 35) Ø1 70

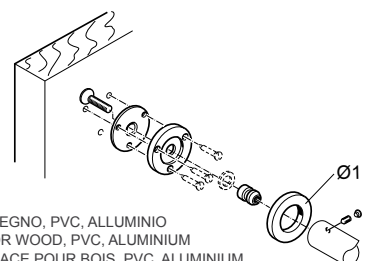

- SINGOLO NON PASSANTE CON ROSETTA PER LEGNO, PVC, ALLUMINIO
- SINGLE NON THROUGH FITTING WITH ROSE FOR WOOD, PVC, ALUMINIUM
- FIXATION SIMPLE NON TRAVERSANT AVEC ROSACE POUR BOIS, PVC, ALUMINIUM
- EINZELBEFESTIGUNG MIT ROSETTEN FÜR ALLE TÜRARTEN
- ENKELE NIET-DOORGAANDE ROZETBEVESTIGING VOOR HOUT, PVC EN ALUMINIUM

FISSAGGI D - FIXINGS D - FIXATIONS D - BEFESTIGUNGEN D - BEVESTIGING D

ART.
FIX.012.000D.81 (Ø 30)
FIX.013.000D.81 (Ø 35)
FIX.014.000D.81 (Ø 20)

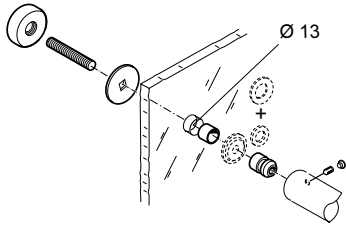

- SINGOLO PASSANTE PER VETRO
- SINGLE THROUGH FITTING FOR GLASS
- FIXATION SIMPLE TRAVERSANT POUR VERRE
- BEFESTIGUNG EINSEITIG DURCHGEHEND FÜR GLASTÜREN
- ENKELE DOORGAANDE BEVESTIGING VOOR GLAS

ART.
FIX.110.000D.81

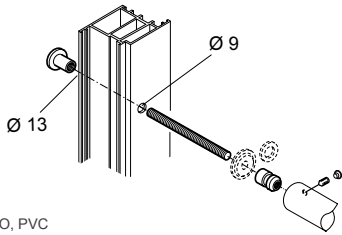

- SINGOLO PASSANTE PER LEGNO, ALLUMINIO, PVC
- SINGLE THROUGH FITTING FOR WOOD, ALUMINIUM, PVC
- FIXATION SIMPLE TRAVERSANT POUR BOIS, ALUMINIUM, PVC
- BEFESTIGUNG EINSEITIG DURCHGEHEND FÜR ALLE TÜRARTEN
- ENKELE DOORGAANDE BEVESTIGING VOOR HOUT, ALUMINIUM EN PVC

ART.
FIX.210.000D.B2

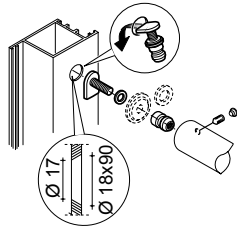

- SINGOLO NON PASSANTE PER PROFILO TUBOLARE
- SINGLE NON THROUGH FITTING FOR TUBULAR PROFILE
- FIXATION SIMPLE NON TRAVERSANT POUR PROFIL TUBULAIRE
- BEFESTIGUNG EINSEITIG UNSICHTBAR FÜR 1-KAMMER KUNSTSTOFFTÜREN
- ENKELE NIET-DOORGAANDE BEVESTIGING VOOR PROFIELEN

ART.
FIX.310.000D.B2

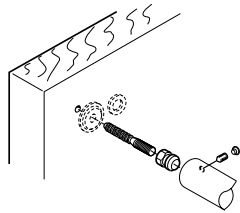

- SINGOLO NON PASSANTE PER LEGNO
- SINGLE NON THROUGH FITTING FOR WOOD
- FIXATION SIMPLE NON TRAVERSANT POUR BOIS
- BEFESTIGUNG EINSEITIG UNSICHTBAR FÜR HOLZTÜREN
- ENKELE NIET-DOORGAANDE BEVESTIGING VOOR HOUT

ART.
FIX.410.000D.B2
A= 33 mm
FIX.410.00DL.B2
A= 50 mm

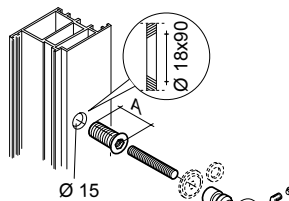

- SINGOLO NON PASSANTE PER LEGNO, PVC, ALLUMINIO A 2-3 CAMERE
- SINGLE NON THROUGH FITTING FOR WOOD, PVC, 2-3 SECTIONS ALUMINIUM
- FIXATION SIMPLE NON TRAVERSANT POUR BOIS, PVC, ALUMINIUM 2-3 SECTIONS
- EINZELBEFESTIGUNG FÜR 3 KAMMER - METALLTÜREN
- ENKELE NIET-DOORGAANDE BEVESTIGING VOOR HOUT, PVC EN ALUMINIUM PROFIELEN MET 2-3 KAMERS

ART.
FIX.510.000D.B2
A= 33 mm
FIX.510.00DL.B2
A= 50 mm

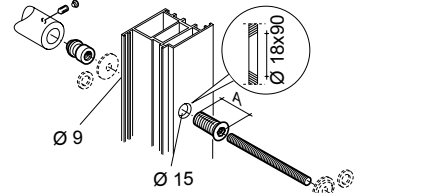

- CONTRAPPOSTO PER LEGNO, PVC, ALLUMINIO A 2-3 CAMERE
- BACK TO BACK FITTING FOR WOOD, PVC, 2-3 SECTIONS ALUMINIUM
- FIXATION SIMPLE NON TRAVERSANT POUR BOIS, PVC, ALUMINIUM 2-3 SECTIONS
- EINZELBEFESTIGUNG FÜR 3 KAMMER - METALLTÜREN
- ENKELE NIET-DOORGAANDE BEVESTIGING VOOR HOUT, PVC EN ALUMINIUM PROFIELEN MET 2-3 KAMERS

ART.
FIX.610.000D.B2

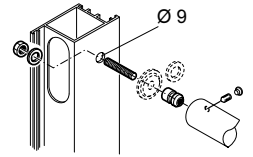

- SINGOLO NON PASSANTE PER PROFILO TUBOLARE
- SINGLE NON THROUGH FITTING FOR TUBULAR PROFILE
- FIXATION SIMPLE NON TRAVERSANT POUR PROFIL TUBULAIRE
- BEFESTIGUNG EINSEITIG UNSICHTBAR FÜR 1-KAMMER KUNSTSTOFFTÜREN
- ENKELE NIET-DOORGAANDE BEVESTIGING VOOR PROFIELEN

ART.
FIX.710.000D.B2

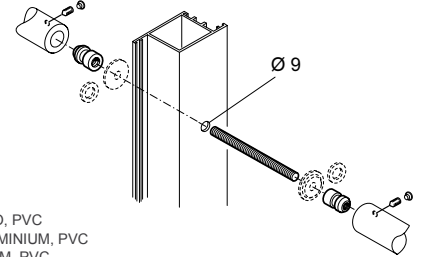

- CONTRAPPOSTO PER LEGNO, ALLUMINIO, PVC
- BACK TO BACK FITTING FOR WOOD, ALUMINIUM, PVC
- FIXATION DOUBLE POUR BOIS, ALUMINIUM, PVC
- BEIDSEITIGE BEFESTIGUNG FÜR ALLE TÜRARTEN
- PAARSGEWIJZE BEVESTIGING VOOR HOUT, ALUMINIUM EN PVC

ART.
FIX.810.000D.B2

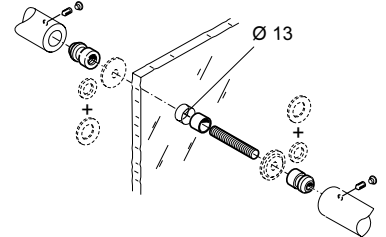

- CONTRAPPOSTO PER VETRO
- BACK TO BACK FITTING FOR GLASS
- FIXATION DOUBLE POUR VERRE
- BEIDSEITIGE BEFESTIGUNG FÜR GLASTÜREN
- PAARSGEWIJZE BEVESTIGING VOOR GLAS

ART.
FIX.912.000D.81 (Ø 30)
FIX.913.000D.81 (Ø 35)
FIX.914.000D.81 (Ø 20)

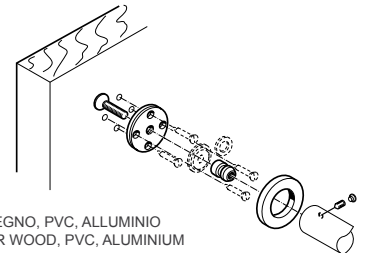

- SINGOLO NON PASSANTE CON ROSETTA PER LEGNO, PVC, ALLUMINIO
- SINGLE NON THROUGH FITTING WITH ROSE FOR WOOD, PVC, ALUMINIUM
- FIXATION SIMPLE NON TRAVERSANT AVEC ROSACE POUR BOIS, PVC, ALUMINIUM
- EINZELBEFESTIGUNG MIT ROSETTEN FÜR ALLE TÜRARTEN
- ENKELE NIET-DOORGAANDE ROZETBEVESTIGING VOOR HOUT, PVC EN ALUMINIUM

FISSAGGI D - FIXINGS D - FIXATIONS D - BEFESTIGUNGEN D - BEVESTIGING D

ART.
FIX.012.000D. xx (Ø 30)
FIX.013.000D. xx (Ø 35)

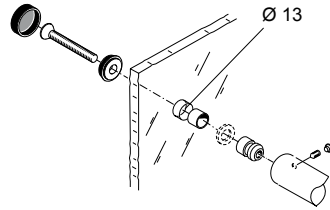

- SINGOLO PASSANTE PER VETRO
- SINGLE THROUGH FITTING FOR GLASS
- FIXATION SIMPLE TRAVERSANT POUR VERRE
- BEFESTIGUNG EINSEITIG DURCHGEHEND FÜR GLASTÜREN
- ENKELE DOORGAANDE BEVESTIGING VOOR GLAS

ART.
FIX.112.000D. xx (Ø 30)
FIX.113.000D. xx (Ø 35)

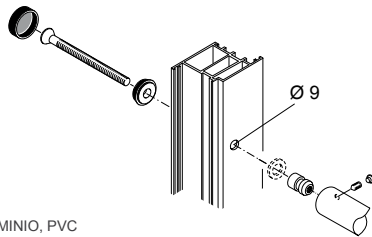

- SINGOLO PASSANTE PER LEGNO, ALLUMINIO, PVC
- SINGLE THROUGH FITTING FOR WOOD, ALUMINIUM, PVC
- FIXATION SIMPLE TRAVERSANT POUR BOIS, ALUMINIUM, PVC
- BEFESTIGUNG EINSEITIG DURCHGEHEND FÜR ALLE TÜRARTEN
- ENKELE DOORGAANDE BEVESTIGING VOOR HOUT, ALUMINIUM EN PVC

ART.
FIX.210.000D.B2

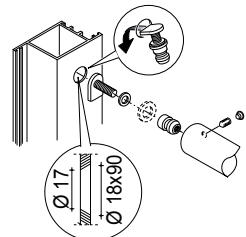

- SINGOLO NON PASSANTE PER PROFILO TUBOLARE
- SINGLE NON THROUGH FITTING FOR TUBULAR PROFILE
- FIXATION SIMPLE NON TRAVERSANT POUR PROFIL TUBULAIRE
- BEFESTIGUNG EINSEITIG UNSICHTBAR FÜR 1-KAMMER KUNSTSTOFFTÜREN
- ENKELE NIET-DOORGAANDE BEVESTIGING VOOR PROFIELEN

ART.
FIX.310.000D.B2

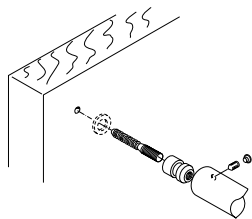

- SINGOLO NON PASSANTE PER LEGNO
- SINGLE NON THROUGH FITTING FOR WOOD
- FIXATION SIMPLE NON TRAVERSANT POUR BOIS
- BEFESTIGUNG EINSEITIG UNSICHTBAR FÜR HOLZTÜREN
- ENKELE NIET-DOORGAANDE BEVESTIGING VOOR HOUT

ART.
FIX.410.000D.B2
A= 33 mm
FIX.410.00DL.B2
A= 50 mm

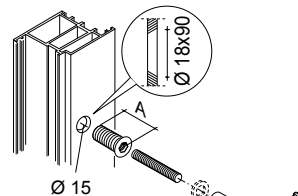

- SINGOLO NON PASSANTE PER LEGNO, PVC, ALLUMINIO A 2-3 CAMERE
- SINGLE NON THROUGH FITTING FOR WOOD, PVC, 2-3 SECTIONS ALUMINIUM
- FIXATION SIMPLE NON TRAVERSANT POUR BOIS, PVC, ALUMINIUM 2-3 SECTIONS
- EINZELBEFESTIGUNG FÜR 3 KAMMER - METALLTÜREN
- ENKELE NIET-DOORGAANDE BEVESTIGING VOOR HOUT, PVC EN ALUMINIUM PROFIELEN MET 2-3 KAMERS

ART.
FIX.510.000D.B2
A= 33 mm
FIX.510.00DL.B2
A= 50 mm

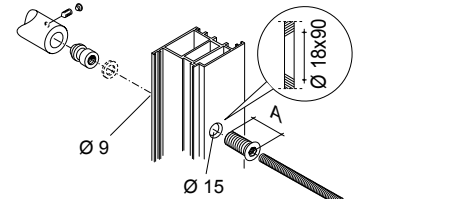

- CONTRAPPOSTO PER LEGNO, PVC, ALLUMINIO A 2-3 CAMERE
- BACK TO BACK FITTING FOR WOOD, PVC, 2-3 SECTIONS ALUMINIUM
- FIXATION SIMPLE NON TRAVERSANT POUR BOIS, PVC, ALUMINIUM 2-3 SECTIONS
- EINZELBEFESTIGUNG FÜR 3 KAMMER - METALLTÜREN
- ENKELE NIET-DOORGAANDE BEVESTIGING VOOR HOUT, PVC EN ALUMINIUM PROFIELEN MET 2-3 KAMERS

ART.
FIX.610.000D.B2

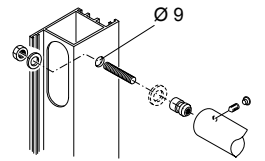

- SINGOLO NON PASSANTE PER PROFILO TUBOLARE
- SINGLE NON THROUGH FITTING FOR TUBULAR PROFILE
- FIXATION SIMPLE NON TRAVERSANT POUR PROFIL TUBULAIRE
- BEFESTIGUNG EINSEITIG UNSICHTBAR FÜR 1-KAMMER KUNSTSTOFFTÜREN
- ENKELE NIET-DOORGAANDE BEVESTIGING VOOR PROFIELEN

ART.
FIX.710.000D.B2

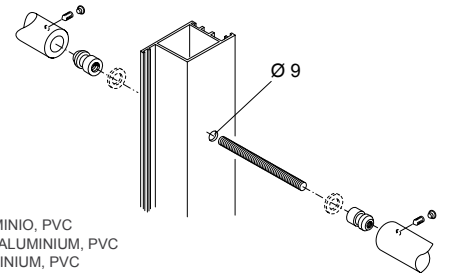

- CONTRAPPOSTO PER LEGNO, ALLUMINIO, PVC
- BACK TO BACK FITTING FOR WOOD, ALUMINIUM, PVC
- FIXATION DOUBLE POUR BOIS, ALUMINIUM, PVC
- BEIDSEITIGE BEFESTIGUNG FÜR ALLE TÜRARTEN
- PAARSGEWIJZE BEVESTIGING VOOR HOUT, ALUMINIUM EN PVC

ART.
FIX.810.000D.B2

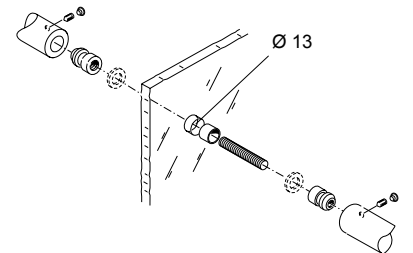

- CONTRAPPOSTO PER VETRO
- BACK TO BACK FITTING FOR GLASS
- FIXATION DOUBLE POUR VERRE
- BEIDSEITIGE BEFESTIGUNG FÜR GLASTÜREN
- PAARSGEWIJZE BEVESTIGING VOOR GLAS

ART.
FIX.912.000D. xx (Ø 30) Ø1
FIX.913.000D. xx (Ø 35) 70

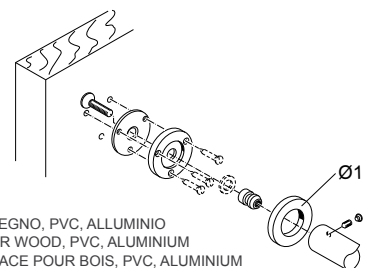

- SINGOLO NON PASSANTE CON ROSETTA PER LEGNO, PVC, ALLUMINIO
- SINGLE NON THROUGH FITTING WITH ROSE FOR WOOD, PVC, ALUMINIUM
- FIXATION SIMPLE NON TRAVERSANT AVEC ROSACE POUR BOIS, PVC, ALUMINIUM
- EINZELBEFESTIGUNG MIT ROSETTEN FÜR ALLE TÜRARTEN
- ENKELE NIET-DOORGAANDE ROZETBEVESTIGING VOOR HOUT, PVC EN ALUMINIUM

US FORMAT

PULL HANDLES

FIXINGS D - FISSAGGI D

FIX.011.000D. xx	Ø 25 mm 1"
FIX.012.000D. xx	30 mm 1 3/16"
FIX.013.000D. xx	35 mm 1 3/8"
FIX.014.000D. xx	20 mm 25/32"
FIX.016.000D. xx	40 mm 1 9/16"

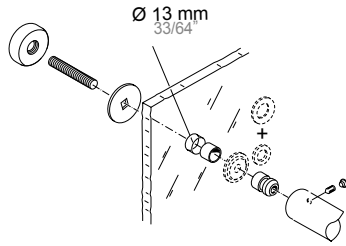

- SINGLE THROUGH FITTING FOR GLASS
- SINGOLO PASSANTE PER VETRO

FIX.110.000D. xx

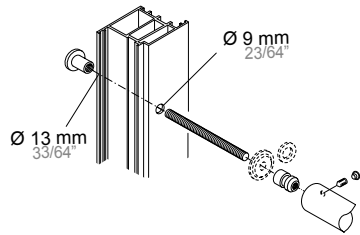

- SINGLE THROUGH FITTING FOR WOOD, ALUMINIUM, PVC
- SINGOLO PASSANTE PER LEGNO, ALLUMINIO, PVC

FIX.210.000D.B2

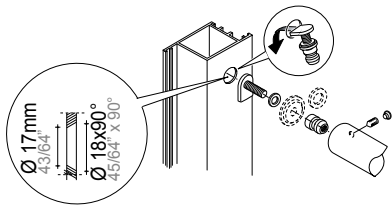

- SINGLE NON THROUGH FITTING FOR TUBULAR PROFILE
- SINGOLO NON PASSANTE PER PROFILO TUBOLARE

FIX.310.000D.B2

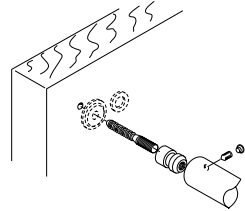

- SINGLE NON THROUGH FITTING FOR WOOD
- SINGOLO NON PASSANTE PER LEGNO

FIX.410.000D.B2

A= 33 mm
1 19/64"

FIX.410.00DL.B2

A= 50 mm
1 31/32"

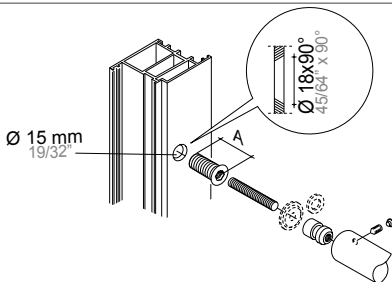

- SINGLE NON THROUGH FITTING FOR WOOD, PVC, 2-3 SECTIONS ALUMINIUM
- SINGOLO NON PASSANTE PER LEGNO, PVC, ALLUMINIO A 2-3 CAMERE

FIX.510.000D.B2

A= 33 mm
1 19/64"

FIX.510.00DL.B2

A= 50 mm
1 31/32"

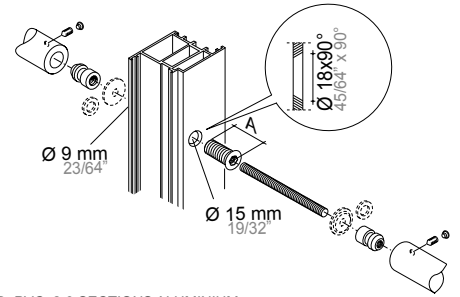

- BACK TO BACK FITTING FOR WOOD, PVC, 2-3 SECTIONS ALUMINIUM
- CONTRAPPOSTO PER LEGNO, PVC, ALLUMINIO A 2-3 CAMERE

FIX.610.000D.B2

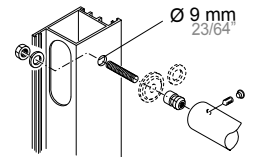

- SINGLE NON THROUGH FITTING FOR TUBULAR PROFILE
- SINGOLO NON PASSANTE PER PROFILO TUBOLARE

FIX.710.000D.B2

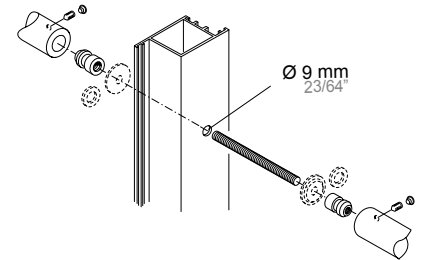

- BACK TO BACK FITTING FOR WOOD, ALUMINIUM, PVC
- CONTRAPPOSTO PER LEGNO, ALLUMINIO, PVC

FIX.810.000D.B2

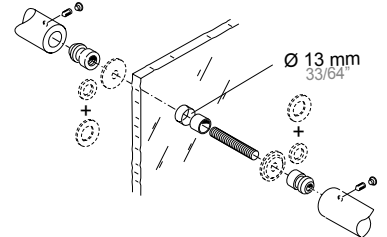

- BACK TO BACK FITTING FOR GLASS
- CONTRAPPOSTO PER VETRO

FIX.911.000D. xx	Ø 25 mm 1"	Ø1 50 mm 1 31/32"
-------------------------	------------------	-------------------------

FIX.912.000D. xx	30 mm 1 3/16"	60 mm 2 23/64"
-------------------------	------------------	-------------------

FIX.913.000D. xx	35 mm 1 3/8"	60 mm 2 23/64"
-------------------------	-----------------	-------------------

FIX.914.000D. xx	20 mm 25/32"	50 mm 1 31/32"
-------------------------	-----------------	-------------------

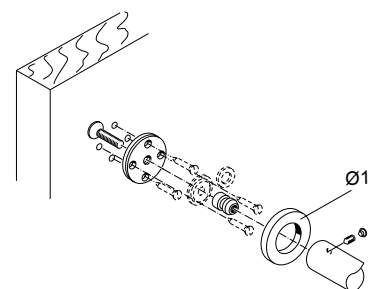

- SINGLE NON THROUGH FITTING WITH ROSE FOR WOOD, PVC, ALUMINIUM
- SINGOLO NON PASSANTE CON ROSETTA PER LEGNO, PVC, ALLUMINIO

PULL HANDLES

FIXINGS I - FISSAGGI I

FIX.025.000I.xx

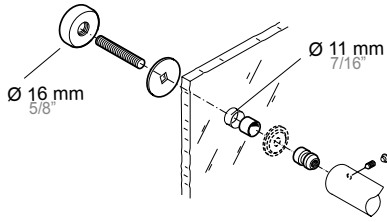

- SINGLE THROUGH FITTING FOR GLASS
- SINGOLO PASSANTE PER VETRO

FIX.120.000I.xx

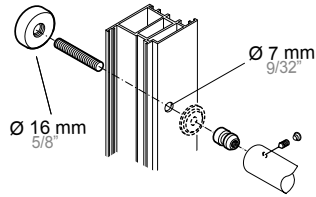

- SINGLE THROUGH FITTING FOR WOOD, ALUMINIUM, PVC
- SINGOLO PASSANTE PER LEGNO, ALLUMINIO, PVC

FIX.220.000I.B2

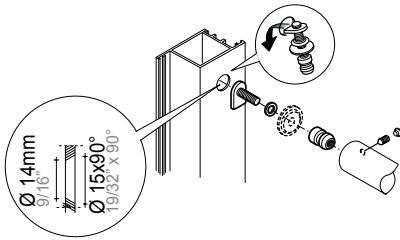

- SINGLE NON THROUGH FITTING FOR TUBULAR PROFILE
- SINGOLO NON PASSANTE PER PROFILO TUBOLARE

FIX.320.000I.B2

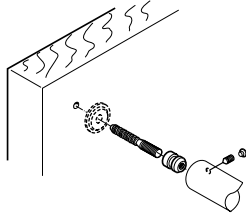

- SINGLE NON THROUGH FITTING FOR WOOD
- SINGOLO NON PASSANTE PER LEGNO

FIX.420.000I.B2

A= 33 mm
1 19/64"

FIX.420.00IL.B2

A= 50 mm
1 31/32"

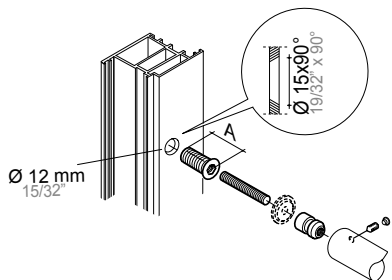

- SINGLE NON THROUGH FITTING FOR WOOD, PVC, 2-3 SECTIONS ALUMINIUM
- SINGOLO NON PASSANTE PER LEGNO, PVC, ALLUMINIO A 2-3 CAMERE

FIX.520.000I.B2

A= 33 mm
1 19/64"

FIX.520.00IL.B2

A= 50 mm
1 31/32"

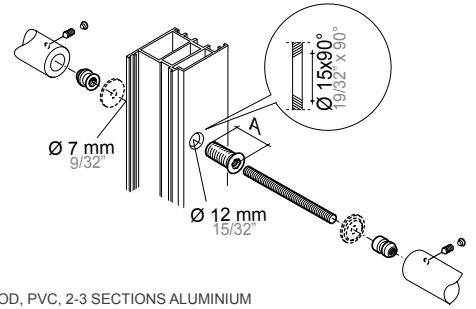

- BACK TO BACK FITTING FOR WOOD, PVC, 2-3 SECTIONS ALUMINIUM
- CONTRAPPOSTO PER LEGNO, PVC, ALLUMINIO A 2-3 CAMERE

FIX.620.000I.B2

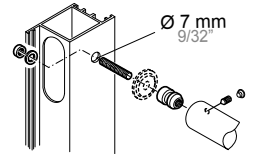

- SINGLE NON THROUGH FITTING FOR TUBULAR PROFILE
- SINGOLO NON PASSANTE PER PROFILO TUBOLARE

FIX.720.000I.B2

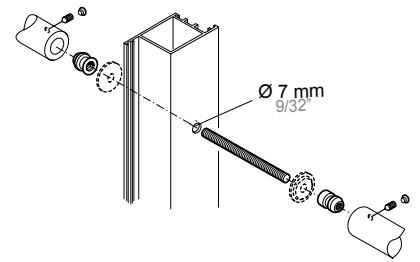

- BACK TO BACK FITTING FOR WOOD, ALUMINIUM, PVC
- CONTRAPPOSTO PER LEGNO, ALLUMINIO, PVC

FIX.820.000I.B2

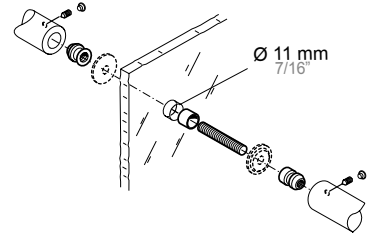

- BACK TO BACK FITTING FOR GLASS
- CONTRAPPOSTO PER VETRO

FIX.925.000I.xx

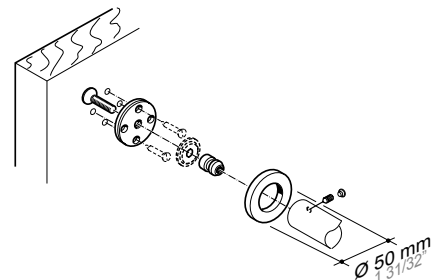

- SINGLE NON THROUGH FITTING WITH ROSE FOR WOOD, PVC, ALUMINIUM
- SINGOLO NON PASSANTE CON ROSETTA PER LEGNO, PVC, ALLUMINIO