











HANDS-FREE PULLS

HANDS-FREE PULLS



CODE	MATERIAL	FINISH	.XX	* indicative colors	
GHF.	STAINLESS STEEL AISI 316L	Standard:			
		BRIGHT <small>on selected items</small>	LRV 70	.43	
		SATIN	LRV 53	.44	
		SATIN GOLD		.80	
		POWDER-COATED	Black Ral 9005 Matt	.40	
			White Ral 9010	.31	
			Grey	.32	
			Champagne	.38	
			Bronze	.39	
		POWDER-COATED	Transparent Bright <small>on selected items</small>	.99	
		AMC	Transparent Satin	.99	
			Black	.99	

Screws, grub screws and plastic parts non powder-coated.
Available on request depending on quantities.

PROGRAMMA
HANDS-FREE PULLS

Stainless Steel AISI 316L
Stainless Steel AISI 316L Powder-coated





LEGEND

page Hands-Free Pulls_3

TECHNICAL REFERENCES

page Hands-Free Pulls_20

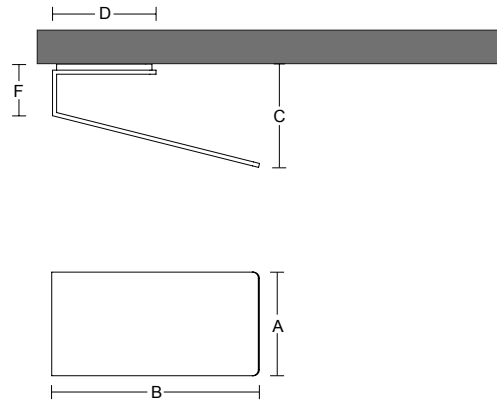

PUSH PLATE AVAILABLE ON PAGE Hnds-Free Pulls_19



OPERABLE WITH WRIST, FOREARM OR ELBOW

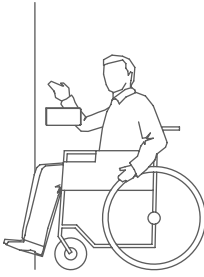

COMPLIANT WITH ADA STANDARDS

ADA
compliant

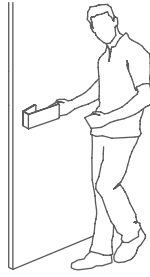

AND STILL OPERABLE BY HAND

Design 1

ITEM	A	B	C	D	F
GHF.D01.0001. xx	101,60 mm 4"	203,20 mm 8"	101,60 mm 4"	101,60 mm 4"	50,80 mm 2"

.XX = FINISH CODE

STAINLESS STEEL

- .44 SATIN STAINLESS STEEL (ANSI/BHMA 630 - USD32D)
- .80 SATIN GOLD STAINLESS STEEL

STAINLESS STEEL POWDER-COATED ON REQUEST

- .40 BLACK RAL 9005
- .31 WHITE RAL 9010
- .32 GREY
- .38 CHAMPAGNE
- .39 BRONZE

STAINLESS STEEL POWDER-COATED ON REQUEST

- .99 TRANSPARENT SATIN
- .99 BLACK



SINGLE FIXING KIT FOR WOOD DOOR INCLUDED
BACK TO BACK FIXINGS AVAILABLE ON REQUEST
FIXING KIT FOR GLASS AND METAL DOOR AVAILABLE ON REQUEST

THESE PRODUCTS CONTRIBUTE TO LEED® CREDITS

THE MANUFACTURER RESERVES THE RIGHT TO ALTER, IMPROVE AND DISCONTINUE ANY FEATURES OF THE PRODUCT (MAKE CHANGES AND IMPROVEMENTS IN DESIGNS AND DIMENSIONS) WITHOUT NOTICE.

ALL DIMENSIONS IN THE CATALOG DRAWINGS ARE APPROXIMATIONS. REQUEST THE APPROPRIATE TECHNICAL DRAWING BEFORE DOOR PREPARATION AND INSTALLATION.



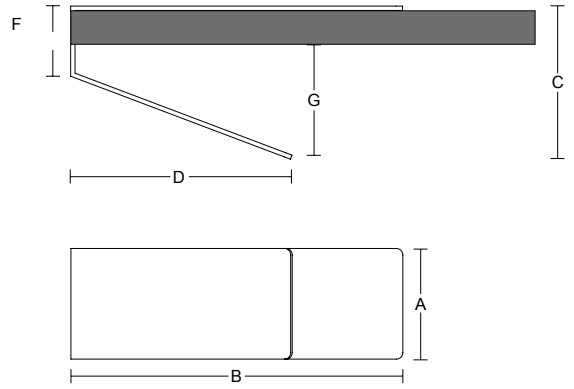

OPERABLE WITH WRIST, FOREARM OR ELBOW

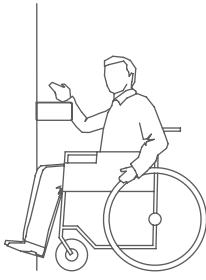

COMPLIANT WITH ADA STANDARDS

ADA
compliant



AND STILL OPERABLE BY HAND

Design 2.1

ITEM	A	B	C	D	F	G
GHF.D02.0001. xx	101,60 mm 4"	304,80 mm 12"	140,60 mm 5 17/32"	203,21 mm 8"	64,40 mm 2 17/32"	Max 101,60 mm 4"

.XX = FINISH CODE

STAINLESS STEEL

- .44 SATIN STAINLESS STEEL (ANSI/BHMA 630 - USD32D)
- .80 SATIN GOLD STAINLESS STEEL

STAINLESS STEEL POWDER-COATED ON REQUEST

- .40 BLACK RAL 9005
- .31 WHITE RAL 9010
- .32 GREY
- .38 CHAMPAGNE
- .39 BRONZE

STAINLESS STEEL POWDER-COATED ON REQUEST

- .99 TRANSPARENT SATIN
- .99 BLACK



SINGLE FIXING KIT FOR WOOD DOOR INCLUDED
 FIXING: SATIN FOR .44 SATIN FINISH - BRIGHT FOR .43 BRIGHT FINISH - BLACK FOR .39 BRONZE, .32 GREY, .40 BLACK FINISH - SATIN FOR .31 WHITE, .38 CHAMPAGNE FINISH

THESE PRODUCTS CONTRIBUTE TO LEED® CREDITS

THE MANUFACTURER RESERVES THE RIGHT TO ALTER, IMPROVE AND DISCONTINUE ANY FEATURES OF THE PRODUCT (MAKE CHANGES AND IMPROVEMENTS IN DESIGNS AND DIMENSIONS) WITHOUT NOTICE.

ALL DIMENSIONS IN THE CATALOG DRAWINGS ARE APPROXIMATIONS. REQUEST THE APPROPRIATE TECHNICAL DRAWING BEFORE DOOR PREPARATION AND INSTALLATION.



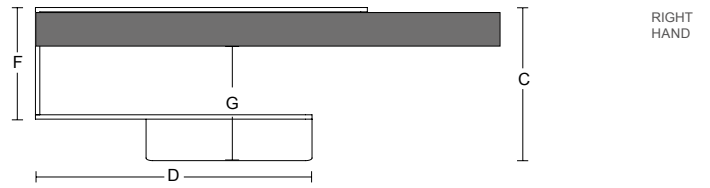

RIGHT HAND

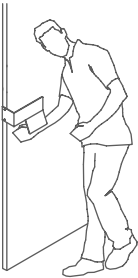
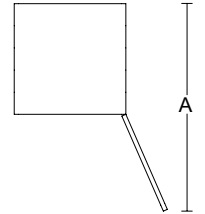
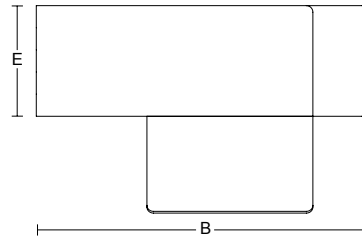

OPERABLE WITH WRIST, FOREARM OR ELBOW

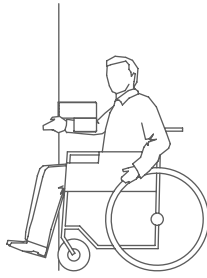

COMPLIANT WITH ADA STANDARDS

ADA
compliant



AND STILL OPERABLE BY HAND

Design 2.2

ITEM	A	B	C	D	E	F	G
GHF.D02.0002. xx	190,50 mm 7 1/2"	304,80 mm 12"	140,60 mm 5 17/32"	254 mm 10"	101,60 mm 4"	102,50 mm 4 1/32"	Max 101,60 mm 4"

.XX = FINISH CODE

STAINLESS STEEL

- .44 SATIN STAINLESS STEEL (ANSI/BHMA 630 - USD32D)
- .80 SATIN GOLD STAINLESS STEEL

STAINLESS STEEL POWDER-COATED ON REQUEST

- .40 BLACK RAL 9005
- .31 WHITE RAL 9010
- .32 GREY
- .38 CHAMPAGNE
- .39 BRONZE

STAINLESS STEEL POWDER-COATED ON REQUEST

- .99 TRANSPARENT SATIN
- .99 BLACK



SINGLE FIXING KIT FOR WOOD DOOR INCLUDED
 FIXING: SATIN FOR .44 SATIN FINISH - BRIGHT FOR .43 BRIGHT FINISH - BLACK FOR .39 BRONZE, .32 GREY, .40 BLACK FINISH - SATIN FOR .31 WHITE, .38 CHAMPAGNE FINISH

THESE PRODUCTS CONTRIBUTE TO LEED® CREDITS

THE MANUFACTURER RESERVES THE RIGHT TO ALTER, IMPROVE AND DISCONTINUE ANY FEATURES OF THE PRODUCT (MAKE CHANGES AND IMPROVEMENTS IN DESIGNS AND DIMENSIONS) WITHOUT NOTICE.

ALL DIMENSIONS IN THE CATALOG DRAWINGS ARE APPROXIMATIONS. REQUEST THE APPROPRIATE TECHNICAL DRAWING BEFORE DOOR PREPARATION AND INSTALLATION.



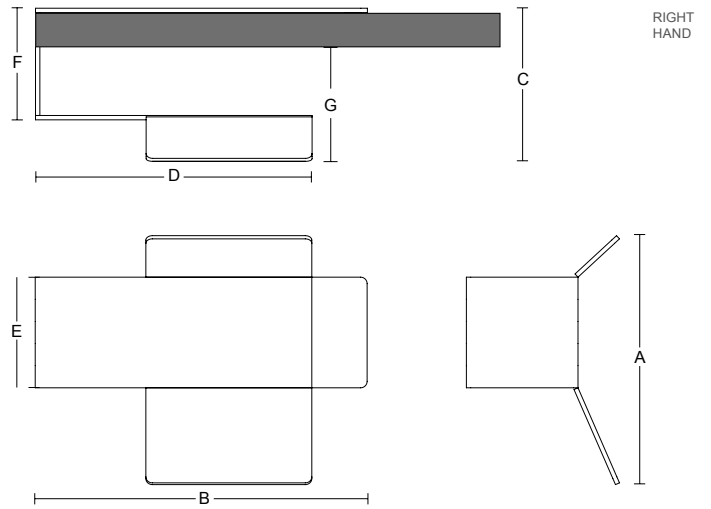

OPERABLE WITH WRIST, FOREARM OR ELBOW

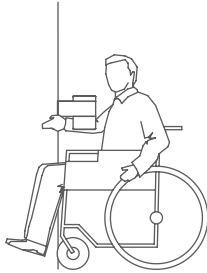

COMPLIANT WITH ADA STANDARDS

ADA
compliant



AND STILL OPERABLE BY HAND

Design 2.3

ITEM	A	B	C	D	E	F	G
GHF.D02.0003. xx	228,60 mm	304,80 mm	140,60 mm	254 mm	101,60 mm	102,50 mm	Max 101,60 mm
	9"	12"	5 17/32"	10"	4"	4 1/32"	4"

.XX = FINISH CODE

STAINLESS STEEL

- .44 SATIN STAINLESS STEEL (ANSI/BHMA 630 - USD32D)
- .80 SATIN GOLD STAINLESS STEEL

STAINLESS STEEL POWDER-COATED ON REQUEST

- .40 BLACK RAL 9005
- .31 WHITE RAL 9010
- .32 GREY
- .38 CHAMPAGNE
- .39 BRONZE

STAINLESS STEEL POWDER-COATED ON REQUEST

- .99 TRANSPARENT SATIN
- .99 BLACK



SINGLE FIXING KIT FOR WOOD DOOR INCLUDED
 FIXING: SATIN FOR .44 SATIN FINISH - BRIGHT FOR .43 BRIGHT FINISH - BLACK FOR .39 BRONZE, .32 GREY, .40 BLACK FINISH - SATIN FOR .31 WHITE, .38 CHAMPAGNE FINISH

THESE PRODUCTS CONTRIBUTE TO LEED® CREDITS

THE MANUFACTURER RESERVES THE RIGHT TO ALTER, IMPROVE AND DISCONTINUE ANY FEATURES OF THE PRODUCT (MAKE CHANGES AND IMPROVEMENTS IN DESIGNS AND DIMENSIONS) WITHOUT NOTICE.

ALL DIMENSIONS IN THE CATALOG DRAWINGS ARE APPROXIMATIONS. REQUEST THE APPROPRIATE TECHNICAL DRAWING BEFORE DOOR PREPARATION AND INSTALLATION.



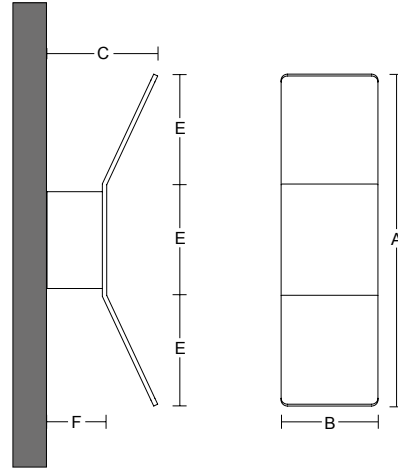

PUSH PLATE AVAILABLE ON PAGE Hnds-Free Pulls_19



OPERABLE WITH WRIST, FOREARM OR ELBOW

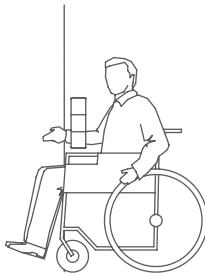

COMPLIANT WITH ADA STANDARDS

ADA
compliant



AND STILL OPERABLE BY HAND

Design 3

ITEM	A	B	C	E	F
GHF.D03.0001. xx	304,80 mm 12"	88,90 mm 3 1/2"	101,60 mm 4"	101,60 mm 4"	54,80 mm 2 5/32"

.XX = FINISH CODE

STAINLESS STEEL

- .43 BRIGHT STAINLESS STEEL (ANSI/BHMA 629 - USD32)
- .44 SATIN STAINLESS STEEL (ANSI/BHMA 630 - USD32D)
- .80 SATIN GOLD STAINLESS STEEL

STAINLESS STEEL POWDER-COATED ON REQUEST

- .40 BLACK RAL 9005
- .31 WHITE RAL 9010
- .32 GREY
- .38 CHAMPAGNE
- .39 BRONZE

STAINLESS STEEL POWDER-COATED ON REQUEST

- .99 TRANSPARENT BRIGHT
- .99 TRANSPARENT SATIN
- .99 BLACK



SINGLE FIXING KIT FOR WOOD DOOR INCLUDED
BACK TO BACK FIXINGS AVAILABLE ON REQUEST
FIXING KIT FOR GLASS AND METAL DOOR AVAILABLE ON REQUEST

THESE PRODUCTS CONTRIBUTE TO **LEED®** CREDITS

THE MANUFACTURER RESERVES THE RIGHT TO ALTER, IMPROVE AND DISCONTINUE ANY FEATURES OF THE PRODUCT (MAKE CHANGES AND IMPROVEMENTS IN DESIGNS AND DIMENSIONS) WITHOUT NOTICE.

ALL DIMENSIONS IN THE CATALOG DRAWINGS ARE APPROXIMATIONS. REQUEST THE APPROPRIATE TECHNICAL DRAWING BEFORE DOOR PREPARATION AND INSTALLATION.



THE INTERNATIONAL EPD SYSTEM



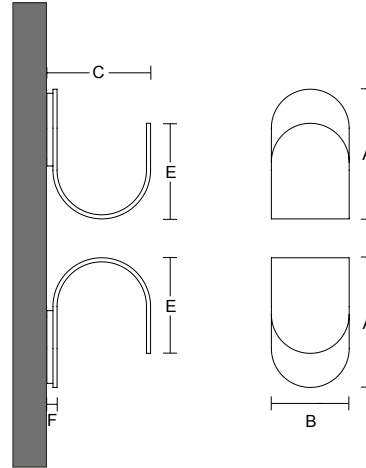

PUSH PLATE AVAILABLE ON PAGE
Hnds-Free Pulls_19



OPERABLE WITH WRIST, FOREARM OR ELBOW

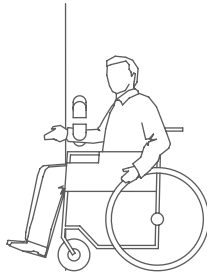

COMPLIANT WITH ADA STANDARDS

ADA
compliant



AND STILL OPERABLE BY HAND

Design 4.1

ITEM	A	B	C	E	F
GHF.D04.0001. xx	127 mm 5"	76,20 mm 3"	101,60 mm 4"	93,60 mm 3 11/16"	10 mm 25/64"

.XX = FINISH CODE

STAINLESS STEEL

- .43 BRIGHT STAINLESS STEEL (ANSI/BHMA 629 - USD32)
- .44 SATIN STAINLESS STEEL (ANSI/BHMA 630 - USD32D)
- .80 SATIN GOLD STAINLESS STEEL

STAINLESS STEEL POWDER-COATED ON REQUEST

- .40 BLACK RAL 9005
- .31 WHITE RAL 9010
- .32 GREY
- .38 CHAMPAGNE
- .39 BRONZE

STAINLESS STEEL POWDER-COATED ON REQUEST

- .99 TRANSPARENT BRIGHT
- .99 TRANSPARENT SATIN
- .99 BLACK



SINGLE FIXING KIT FOR WOOD DOOR INCLUDED
BACK TO BACK FIXINGS AVAILABLE ON REQUEST
FIXING KIT FOR GLASS AND METAL DOOR AVAILABLE ON REQUEST

THESE PRODUCTS CONTRIBUTE TO **LEED®** CREDITS

THE MANUFACTURER RESERVES THE RIGHT TO ALTER, IMPROVE AND DISCONTINUE ANY FEATURES OF THE PRODUCT (MAKE CHANGES AND IMPROVEMENTS IN DESIGNS AND DIMENSIONS) WITHOUT NOTICE.

ALL DIMENSIONS IN THE CATALOG DRAWINGS ARE APPROXIMATIONS. REQUEST THE APPROPRIATE TECHNICAL DRAWING BEFORE DOOR PREPARATION AND INSTALLATION.



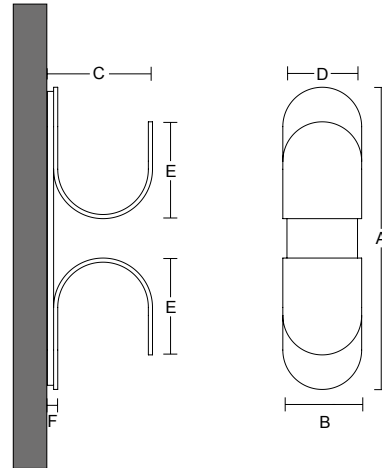

PUSH PLATE AVAILABLE ON PAGE Hnds-Free Pulls_19



OPERABLE WITH WRIST, FOREARM OR ELBOW

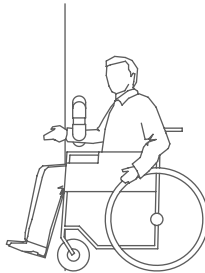

COMPLIANT WITH ADA STANDARDS

ADA
compliant



AND STILL OPERABLE BY HAND

Design 4.2

ITEM	A	B	C	D	E	F
GHF.D04.0002. xx	292,10 mm 11 1/2"	76,20 mm 3"	101,60 mm 4"	68,20 mm 2 11/16"	93,60 mm 3 11/16"	10 mm 25/64"

.XX = FINISH CODE

STAINLESS STEEL

- .43 BRIGHT STAINLESS STEEL (ANSI/BHMA 629 - USD32)
- .44 SATIN STAINLESS STEEL (ANSI/BHMA 630 - USD32D)
- .80 SATIN GOLD STAINLESS STEEL

STAINLESS STEEL POWDER-COATED ON REQUEST

- .40 BLACK RAL 9005
- .31 WHITE RAL 9010
- .32 GREY
- .38 CHAMPAGNE
- .39 BRONZE

STAINLESS STEEL POWDER-COATED ON REQUEST

- .99 TRANSPARENT BRIGHT
- .99 TRANSPARENT SATIN
- .99 BLACK



SINGLE FIXING KIT FOR WOOD DOOR INCLUDED
BACK TO BACK FIXINGS AVAILABLE ON REQUEST
FIXING KIT FOR GLASS AND METAL DOOR AVAILABLE ON REQUEST

THESE PRODUCTS CONTRIBUTE TO **LEED®** CREDITS

THE MANUFACTURER RESERVES THE RIGHT TO ALTER, IMPROVE AND DISCONTINUE ANY FEATURES OF THE PRODUCT (MAKE CHANGES AND IMPROVEMENTS IN DESIGNS AND DIMENSIONS) WITHOUT NOTICE.

ALL DIMENSIONS IN THE CATALOG DRAWINGS ARE APPROXIMATIONS. REQUEST THE APPROPRIATE TECHNICAL DRAWING BEFORE DOOR PREPARATION AND INSTALLATION.



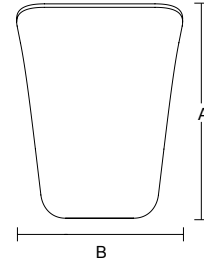
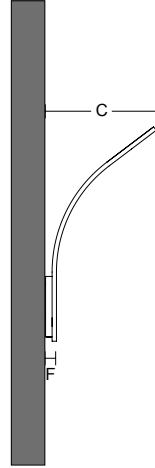

PUSH PLATE AVAILABLE
ON PAGE
Hnds-Free Pulls_19



OPERABLE WITH
WRIST, FOREARM
OR ELBOW



COMPLIANT WITH
ADA STANDARDS

ADA
compliant



AND STILL OPERABLE
BY HAND

Design 5.1

ITEM	A	B	C	F
GHF.D05.0001. xx	196,85 mm 7 3/4"	152,40 mm 6"	101,60 mm 4"	10 mm 25/64"

.XX = FINISH CODE

STAINLESS STEEL

- .43 BRIGHT STAINLESS STEEL (ANSI/BHMA 629 - USD32)
- .44 SATIN STAINLESS STEEL (ANSI/BHMA 630 - USD32D)
- .80 SATIN GOLD STAINLESS STEEL

STAINLESS STEEL POWDER-COATED ON REQUEST

- .40 BLACK RAL 9005
- .31 WHITE RAL 9010
- .32 GREY
- .38 CHAMPAGNE
- .39 BRONZE

STAINLESS STEEL POWDER-COATED ON REQUEST

- .99 TRANSPARENT BRIGHT
- .99 TRANSPARENT SATIN
- .99 BLACK



SINGLE FIXING KIT FOR WOOD DOOR INCLUDED
BACK TO BACK FIXINGS AVAILABLE ON REQUEST
FIXING KIT FOR GLASS AND METAL DOOR AVAILABLE ON REQUEST

THESE PRODUCTS CONTRIBUTE TO **LEED®** CREDITS

THE MANUFACTURER RESERVES THE RIGHT TO ALTER, IMPROVE AND DISCONTINUE ANY FEATURES OF THE PRODUCT (MAKE CHANGES AND IMPROVEMENTS IN DESIGNS AND DIMENSIONS) WITHOUT NOTICE.

ALL DIMENSIONS IN THE CATALOG DRAWINGS ARE APPROXIMATIONS. REQUEST THE APPROPRIATE TECHNICAL DRAWING BEFORE DOOR PREPARATION AND INSTALLATION.



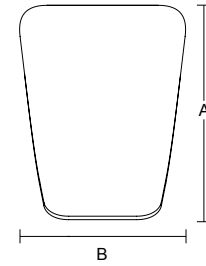
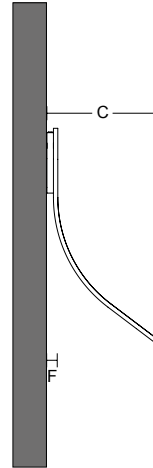

PUSH PLATE AVAILABLE
ON PAGE
Hnds-Free Pulls_19



OPERABLE WITH
WRIST, FOREARM
OR ELBOW

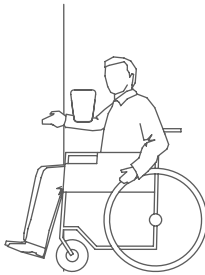

COMPLIANT WITH
ADA STANDARDS

ADA
compliant



AND STILL OPERABLE
BY HAND

Design 5.2

ITEM	A	B	C	F
GHF.D05.0002. xx	196,85 mm 7 3/4"	152,40 mm 6"	101,60 mm 4"	10 mm 25/64"

.XX = FINISH CODE

STAINLESS STEEL

- .43 BRIGHT STAINLESS STEEL (ANSI/BHMA 629 - USD32)
- .44 SATIN STAINLESS STEEL (ANSI/BHMA 630 - USD32D)
- .80 SATIN GOLD STAINLESS STEEL

STAINLESS STEEL POWDER-COATED ON REQUEST

- .40 BLACK RAL 9005
- .31 WHITE RAL 9010
- .32 GREY
- .38 CHAMPAGNE
- .39 BRONZE

STAINLESS STEEL POWDER-COATED ON REQUEST

- .99 TRANSPARENT BRIGHT
- .99 TRANSPARENT SATIN
- .99 BLACK



SINGLE FIXING KIT FOR WOOD DOOR INCLUDED
BACK TO BACK FIXINGS AVAILABLE ON REQUEST
FIXING KIT FOR GLASS AND METAL DOOR AVAILABLE ON REQUEST

THESE PRODUCTS CONTRIBUTE TO **LEED®** CREDITS

THE MANUFACTURER RESERVES THE RIGHT TO ALTER, IMPROVE AND DISCONTINUE ANY FEATURES OF THE PRODUCT (MAKE CHANGES AND IMPROVEMENTS IN DESIGNS AND DIMENSIONS) WITHOUT NOTICE.

ALL DIMENSIONS IN THE CATALOG DRAWINGS ARE APPROXIMATIONS. REQUEST THE APPROPRIATE TECHNICAL DRAWING BEFORE DOOR PREPARATION AND INSTALLATION.



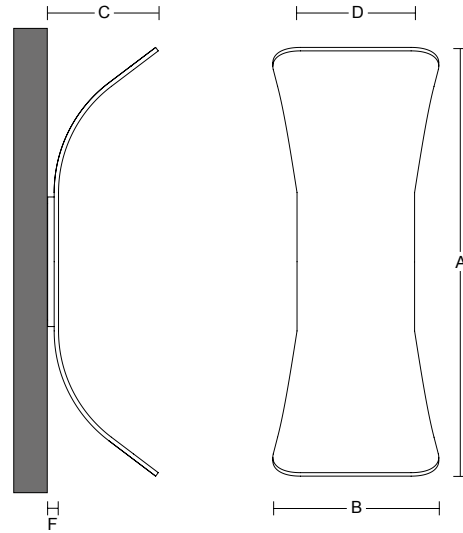

PUSH PLATE AVAILABLE ON PAGE Hnds-Free Pulls_19



OPERABLE WITH WRIST, FOREARM OR ELBOW

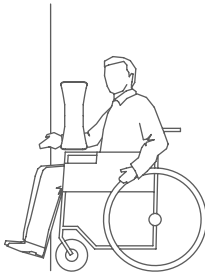

COMPLIANT WITH ADA STANDARDS

ADA
compliant



AND STILL OPERABLE BY HAND

Design 6.1

ITEM	A	B	C	D	F
GHF.D06.0001. xx	393,70 mm 15 1/2"	152,40 mm 6"	101,60 mm 4"	107,95 mm 4 1/4"	10 mm 25/64"

.XX = FINISH CODE

STAINLESS STEEL

- .43 BRIGHT STAINLESS STEEL (ANSI/BHMA 629 - USD32)
- .44 SATIN STAINLESS STEEL (ANSI/BHMA 630 - USD32D)
- .80 SATIN GOLD STAINLESS STEEL

STAINLESS STEEL POWDER-COATED ON REQUEST

- .40 BLACK RAL 9005
- .31 WHITE RAL 9010
- .32 GREY
- .38 CHAMPAGNE
- .39 BRONZE

STAINLESS STEEL POWDER-COATED ON REQUEST

- .99 TRANSPARENT BRIGHT
- .99 TRANSPARENT SATIN
- .99 BLACK



SINGLE FIXING KIT FOR WOOD DOOR INCLUDED
BACK TO BACK FIXINGS AVAILABLE ON REQUEST
FIXING KIT FOR GLASS AND METAL DOOR AVAILABLE ON REQUEST

THESE PRODUCTS CONTRIBUTE TO **LEED®** CREDITS

THE MANUFACTURER RESERVES THE RIGHT TO ALTER, IMPROVE AND DISCONTINUE ANY FEATURES OF THE PRODUCT (MAKE CHANGES AND IMPROVEMENTS IN DESIGNS AND DIMENSIONS) WITHOUT NOTICE.

ALL DIMENSIONS IN THE CATALOG DRAWINGS ARE APPROXIMATIONS. REQUEST THE APPROPRIATE TECHNICAL DRAWING BEFORE DOOR PREPARATION AND INSTALLATION.



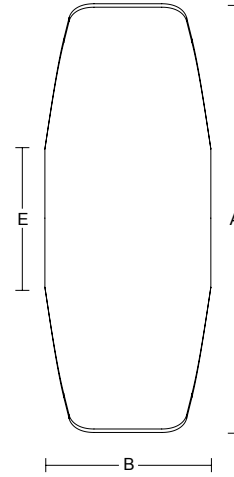
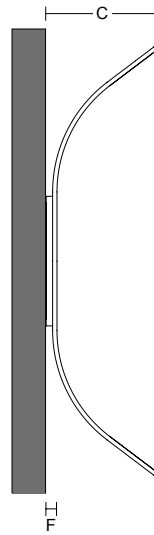

PUSH PLATE AVAILABLE ON PAGE Hnds-Free Pulls_19



OPERABLE WITH WRIST, FOREARM OR ELBOW

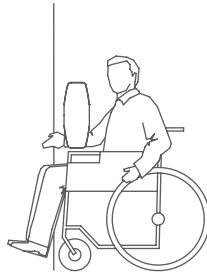

COMPLIANT WITH ADA STANDARDS

ADA
compliant



AND STILL OPERABLE BY HAND

Design 6.2

ITEM	A	B	C	E	F
GHF.D06.0002. xx	393,70 mm 15 1/2"	152,40 mm 6"	101,60 mm 4"	127 mm 5"	10 mm 25/64"

.XX = FINISH CODE

STAINLESS STEEL

- .43 BRIGHT STAINLESS STEEL (ANSI/BHMA 629 - USD32)
- .44 SATIN STAINLESS STEEL (ANSI/BHMA 630 - USD32D)
- .80 SATIN GOLD STAINLESS STEEL

STAINLESS STEEL POWDER-COATED ON REQUEST

- .40 BLACK RAL 9005
- .31 WHITE RAL 9010
- .32 GREY
- .38 CHAMPAGNE
- .39 BRONZE

STAINLESS STEEL POWDER-COATED ON REQUEST

- .99 TRANSPARENT BRIGHT
- .99 TRANSPARENT SATIN
- .99 BLACK



SINGLE FIXING KIT FOR WOOD DOOR INCLUDED
BACK TO BACK FIXINGS AVAILABLE ON REQUEST
FIXING KIT FOR GLASS AND METAL DOOR AVAILABLE ON REQUEST

THESE PRODUCTS CONTRIBUTE TO **LEED®** CREDITS

THE MANUFACTURER RESERVES THE RIGHT TO ALTER, IMPROVE AND DISCONTINUE ANY FEATURES OF THE PRODUCT (MAKE CHANGES AND IMPROVEMENTS IN DESIGNS AND DIMENSIONS) WITHOUT NOTICE.

ALL DIMENSIONS IN THE CATALOG DRAWINGS ARE APPROXIMATIONS. REQUEST THE APPROPRIATE TECHNICAL DRAWING BEFORE DOOR PREPARATION AND INSTALLATION.



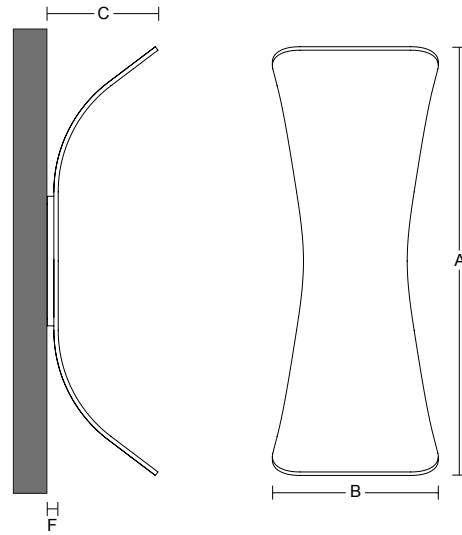

PUSH PLATE AVAILABLE ON PAGE Hnds-Free Pulls_19



OPERABLE WITH WRIST, FOREARM OR ELBOW

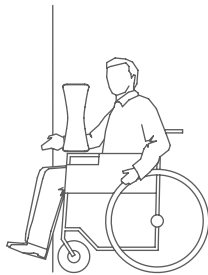

COMPLIANT WITH ADA STANDARDS

ADA
compliant



AND STILL OPERABLE BY HAND

Design 6.3

ITEM	A	B	C	F
GHF.D06.0003. xx	393,70 mm 15 1/2"	152,40 mm 6"	101,60 mm 4"	10 mm 25/64"

.XX = FINISH CODE

STAINLESS STEEL

- .43 BRIGHT STAINLESS STEEL (ANSI/BHMA 629 - USD32)
- .44 SATIN STAINLESS STEEL (ANSI/BHMA 630 - USD32D)
- .80 SATIN GOLD STAINLESS STEEL

STAINLESS STEEL POWDER-COATED ON REQUEST

- .40 BLACK RAL 9005
- .31 WHITE RAL 9010
- .32 GREY
- .38 CHAMPAGNE
- .39 BRONZE

STAINLESS STEEL POWDER-COATED ON REQUEST

- .99 TRANSPARENT BRIGHT
- .99 TRANSPARENT SATIN
- .99 BLACK



SINGLE FIXING KIT FOR WOOD DOOR INCLUDED
 BACK TO BACK FIXINGS AVAILABLE ON REQUEST
 FIXING KIT FOR GLASS AND METAL DOOR AVAILABLE ON REQUEST

THESE PRODUCTS CONTRIBUTE TO **LEED®** CREDITS

THE MANUFACTURER RESERVES THE RIGHT TO ALTER, IMPROVE AND DISCONTINUE ANY FEATURES OF THE PRODUCT (MAKE CHANGES AND IMPROVEMENTS IN DESIGNS AND DIMENSIONS) WITHOUT NOTICE.

ALL DIMENSIONS IN THE CATALOG DRAWINGS ARE APPROXIMATIONS. REQUEST THE APPROPRIATE TECHNICAL DRAWING BEFORE DOOR PREPARATION AND INSTALLATION.



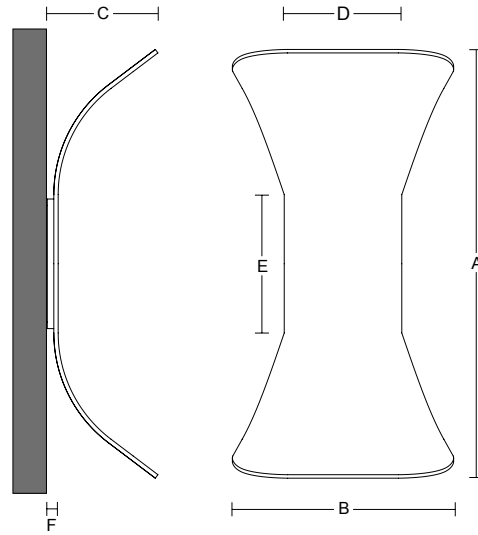

PUSH PLATE AVAILABLE ON PAGE Hnds-Free Pulls_19



OPERABLE WITH WRIST, FOREARM OR ELBOW

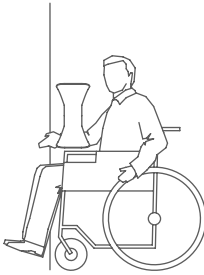

COMPLIANT WITH ADA STANDARDS

ADA
compliant



AND STILL OPERABLE BY HAND

Design 6.4

ITEM	A	B	C	D	E	F
GHF.D06.0004.xx	393,70 mm 15 1/2"	203,20 mm 8"	101,60 mm 4"	107,95 mm 4 1/4"	127 mm 5"	10 mm 25/64"

.XX = FINISH CODE

STAINLESS STEEL

- .43 BRIGHT STAINLESS STEEL (ANSI/BHMA 629 - USD32)
- .44 SATIN STAINLESS STEEL (ANSI/BHMA 630 - USD32D)
- .80 SATIN GOLD STAINLESS STEEL

STAINLESS STEEL POWDER-COATED ON REQUEST

- .40 BLACK RAL 9005
- .31 WHITE RAL 9010
- .32 GREY
- .38 CHAMPAGNE
- .39 BRONZE

STAINLESS STEEL POWDER-COATED ON REQUEST

- .99 TRANSPARENT BRIGHT
- .99 TRANSPARENT SATIN
- .99 BLACK



SINGLE FIXING KIT FOR WOOD DOOR INCLUDED
BACK TO BACK FIXINGS AVAILABLE ON REQUEST
FIXING KIT FOR GLASS AND METAL DOOR AVAILABLE ON REQUEST

THESE PRODUCTS CONTRIBUTE TO **LEED®** CREDITS

THE MANUFACTURER RESERVES THE RIGHT TO ALTER, IMPROVE AND DISCONTINUE ANY FEATURES OF THE PRODUCT (MAKE CHANGES AND IMPROVEMENTS IN DESIGNS AND DIMENSIONS) WITHOUT NOTICE.

ALL DIMENSIONS IN THE CATALOG DRAWINGS ARE APPROXIMATIONS. REQUEST THE APPROPRIATE TECHNICAL DRAWING BEFORE DOOR PREPARATION AND INSTALLATION.



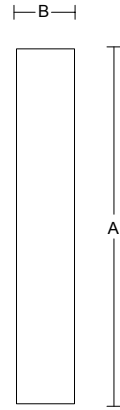
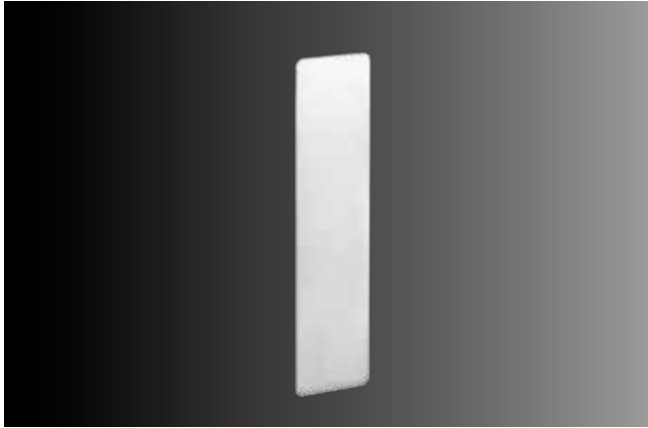

MIN 5/64" (2mm)
MAX 5/16" (8mm)



OPERABLE WITH WRIST, FOREARM OR ELBOW

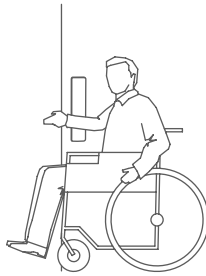

COMPLIANT WITH ADA STANDARDS

ADA
compliant



AND STILL OPERABLE BY HAND

Push Plate

ITEM	A	B	C	F
GHF.D06.0003.xx	393,70 mm 15 1/2"	152,40 mm 6"	101,60 mm 4"	10 mm 25/64"

.XX = FINISH CODE

STAINLESS STEEL

- .43 BRIGHT STAINLESS STEEL (ANSI/BHMA 629 - USD32)
- .44 SATIN STAINLESS STEEL (ANSI/BHMA 630 - USD32D)
- .80 SATIN GOLD STAINLESS STEEL

STAINLESS STEEL POWDER-COATED ON REQUEST

- .40 BLACK RAL 9005
- .31 WHITE RAL 9010
- .32 GREY
- .38 CHAMPAGNE
- .39 BRONZE

STAINLESS STEEL POWDER-COATED ON REQUEST

- .99 TRANSPARENT BRIGHT
- .99 TRANSPARENT SATIN
- .99 BLACK



SINGLE FIXING KIT FOR WOOD DOOR INCLUDED
BACK TO BACK FIXINGS AVAILABLE ON REQUEST
FIXING KIT FOR GLASS AND METAL DOOR AVAILABLE ON REQUEST

THESE PRODUCTS CONTRIBUTE TO **LEED®** CREDITS

THE MANUFACTURER RESERVES THE RIGHT TO ALTER, IMPROVE AND DISCONTINUE ANY FEATURES OF THE PRODUCT (MAKE CHANGES AND IMPROVEMENTS IN DESIGNS AND DIMENSIONS) WITHOUT NOTICE.

ALL DIMENSIONS IN THE CATALOG DRAWINGS ARE APPROXIMATIONS. REQUEST THE APPROPRIATE TECHNICAL DRAWING BEFORE DOOR PREPARATION AND INSTALLATION.



TECHNICAL INFORMATION

PBA ANTIMICROBIAL COATING (AMC)

AMC

THE USE OF PRODUCTS WITH ANTIMICROBIAL SURFACES IS BECOMING A MORE IMPORTANT WAY TO CREATE CLEANER, MORE HYGIENIC ENVIRONMENTS WITH REDUCED OPPORTUNITIES FOR THE PROLIFERATION AND TRANSMISSION OF GERMS. THE **PBA ANTIMICROBIAL COATING (AMC)** SURFACE FINISH IS A VALID ANSWER TO THIS BINDING NEED.

THE **PBA ANTIMICROBIAL COATING (AMC)** SURFACE FINISHING CONTAINS SPECIAL ADDITIVES THAT MAKE THE SURFACE PROTECTED FROM BACTERIA AND MICROORGANISMS. THE TESTS SHOW THAT ON UNTREATED SURFACES THE MICROBES AND BACTERIA CAN EASILY PROLIFERATE WHILE ON THE TREATED SURFACES THE BACTERIAL PROLIFERATION IS PRACTICALLY ZEROED.

THE FOUNDATION FOR SUCCESSFULLY FIGHTING GERM GROWTH CONSISTS OF A THREE ACTION MECHANISMS: BLOCKAGE OF PRIMARY CELL METABOLISM, STOPPAGE OF CELLULAR RESPIRATION, PREVENTION OF CELL DIVISION.

SURFACES WITH **PBA ANTIMICROBIAL COATING (AMC)** HAVE BEEN TESTED TO BE ACTIVE AGAINST GRAM-POSITIVE (STAPHYLOCOCCUS AUREUS - MRSA, BACILLUS SUBTILIS, STREPTOCOCCUS DAECALIS, AND OTHERS) AND GRAM-NEGATIVE BACTERIA (ESCHERICHIA COLI - ESB, LEGIONELLA PNEUMOPHILA, PSEUDOMONAS AERUGINOSA AND OTHERS).

TRIED AND TESTED EFFICACY DEMONSTRATES THAT **PBA ANTIMICROBIAL COATING (AMC)** REDUCES MULTI-RESISTANT GERMS BY 99.99%.

PBA ANTIMICROBIAL COATING (AMC) IS RECOMMENDED FOR ALL THE HYGIENE-SENSITIVE AREAS SUCH AS HOSPITALS AND RETIREMENT HOME, OFFICES AND RETAIL AND GENERALLY FOR PUBLIC BUILDINGS AND HOTELS.

ALL PBA PRODUCTS IN STAINLESS STEEL AND ALUMINUM CAN BE TREATED WITH **PBA ANTIMICROBIAL COATING (AMC)**.

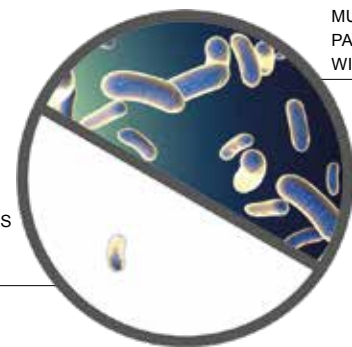

MULTI-RESISTANT
PATHOGENS DEVELOP
WITHOUT PBA AMC

PBA AMC REDUCES
PATHOGENS
BY 99.99%

TRIED AND TESTED EFFICACY REDUCES MULTI-RESISTANT PATHOGENS BY 99.99%. (EFFECT OF ANTI-BACTERIAL ACTIVITY ON STAINLESS STEEL SURFACES.)

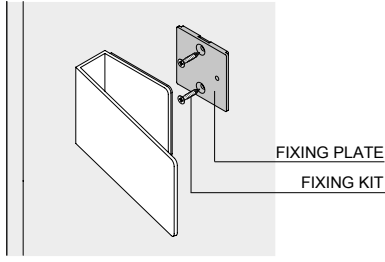
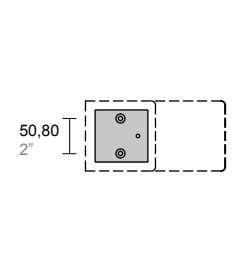
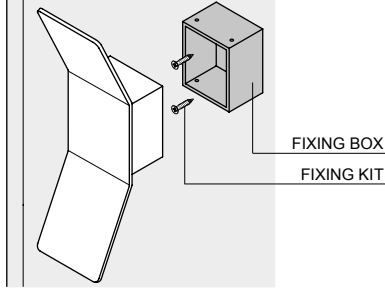
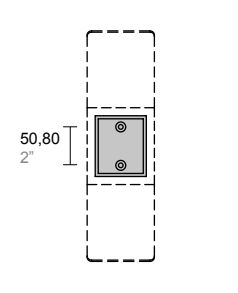
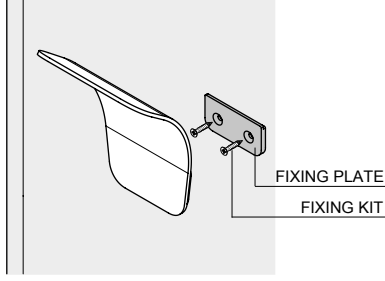
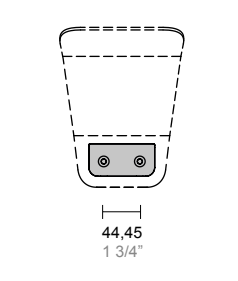
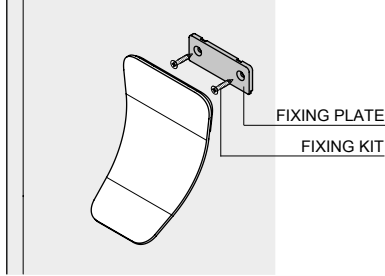
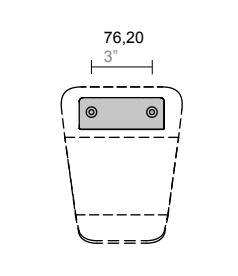
ITEM	FIXING PLATE INCLUDED	SINGLE SIDE FIXING KIT FOR WOOD DOOR	FIXING PLATE DETAILS	DOOR THICKNESS
<p>Design 1 GHF.D01.0001. xx</p>		<p>GHF.FIX.0001. 00</p>		<p>MIN 1 1/2" (38 mm)</p>
<p>Design 3 GHF.D03.0001. xx</p>		<p>GHF.FIX.0001. 00</p>		<p>MIN 1 1/2" (38 mm)</p>
<p>Design 5.1 GHF.D05.0001. xx</p>		<p>GHF.FIX.0001. 00</p>		<p>MIN 1 1/2" (38 mm)</p>
<p>Design 5.2 GHF.D05.0002. xx</p>		<p>GHF.FIX.0001. 00</p>		<p>MIN 1 1/2" (38 mm)</p>

NOTE:
 Back to back fixings available on request
 Fixing kit for glass and metal door available on request
 Push plate for single through fixing

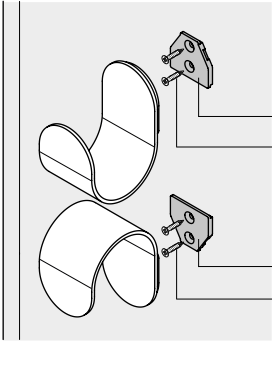
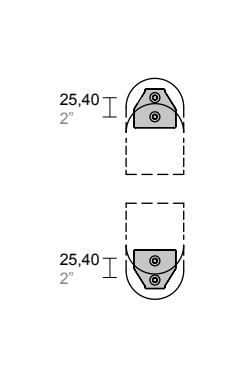
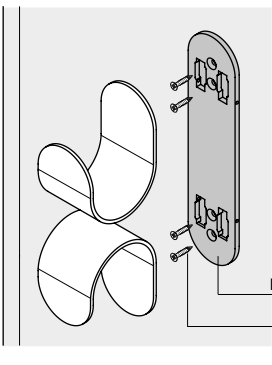
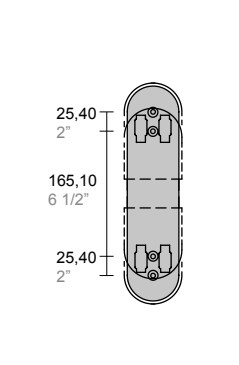
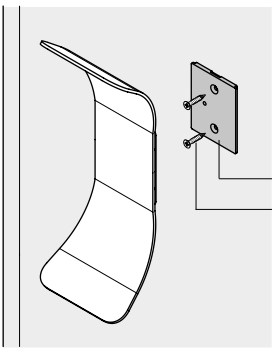
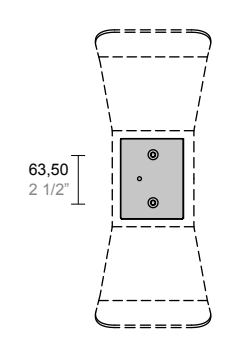
ITEM	FIXING PLATE INCLUDED	SINGLE SIDE FIXING KIT FOR WOOD DOOR	FIXING PLATE DETAILS	DOOR THICKNESS
<p>Design 4.1 GHF.D04.0001. xx</p>	 <p>FIXING PLATE FIXING KIT</p> <p>FIXING PLATE FIXING KIT</p>	<p>GHF.FIX.0001. 00 *</p> <p>* 2 FIXING KITS NEEDED</p>	 <p>25,40 2"</p> <p>25,40 2"</p>	<p>MIN 1 1/2" (38 mm)</p>
<p>Design 4.2 GHF.D04.0002. xx</p>	 <p>FIXING PLATE FIXING KIT</p>	<p>GHF.FIX.0001. 00 *</p> <p>* 2 FIXING KITS NEEDED</p>	 <p>25,40 2"</p> <p>165,10 6 1/2"</p> <p>25,40 2"</p>	<p>MIN 1 1/2" (38 mm)</p>
<p>Design 6.1 GHF.D06.0001. xx</p>	 <p>FIXING PLATE FIXING KIT</p>	<p>GHF.FIX.0001. 00</p>	 <p>63,50 2 1/2"</p>	<p>MIN 1 1/2" (38 mm)</p>

NOTE:
 Back to back fixings available on request
 Fixing kit for glass and metal door available on request
 Push plate for single through fixing

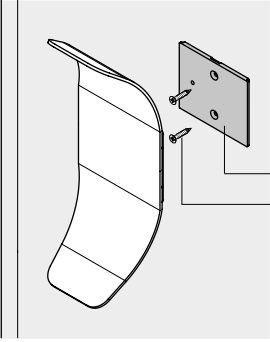
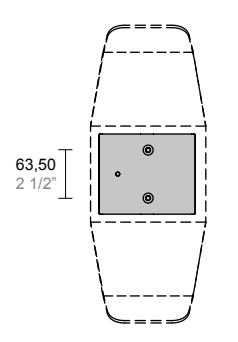
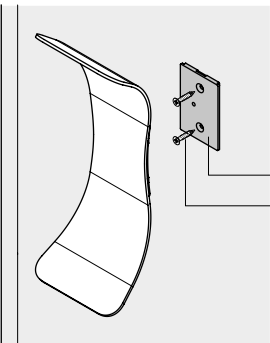
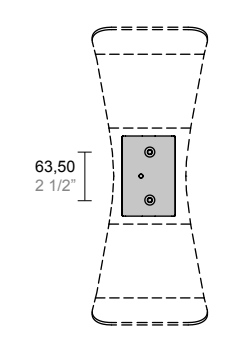
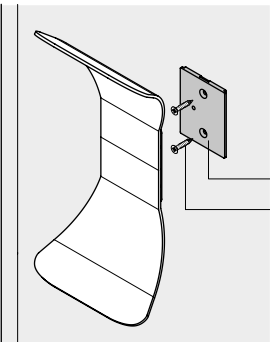
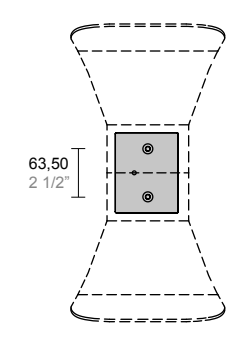
ITEM	FIXING PLATE INCLUDED	SINGLE SIDE FIXING KIT FOR WOOD DOOR	FIXING PLATE DETAILS	DOOR THICKNESS
<p>Design 6.2 GHF.D06.0002. xx</p>	 <p>FIXING PLATE FIXING KIT</p>	<p>GHF.FIX.0001. 00</p>	 <p>63,50 2 1/2"</p>	<p>MIN 1 1/2" (38 mm)</p>
<p>Design 6.3 GHF.D06.0003. xx</p>	 <p>FIXING PLATE FIXING KIT</p>	<p>GHF.FIX.0001. 00</p>	 <p>63,50 2 1/2"</p>	<p>MIN 1 1/2" (38 mm)</p>
<p>Design 6.4 GHF.D06.0004. xx</p>	 <p>FIXING PLATE FIXING KIT</p>	<p>GHF.FIX.0001. 00</p>	 <p>63,50 2 1/2"</p>	<p>MIN 1 1/2" (38 mm)</p>

NOTE:
 Back to back fixings available on request
 Fixing kit for glass and metal door available on request
 Push plate for single through fixing

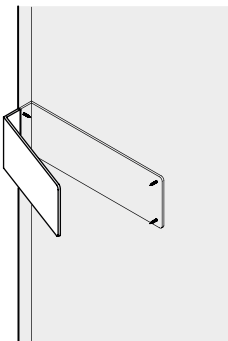
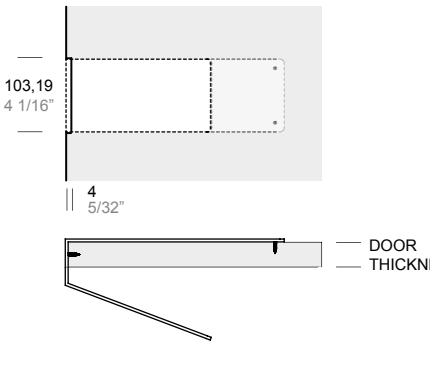
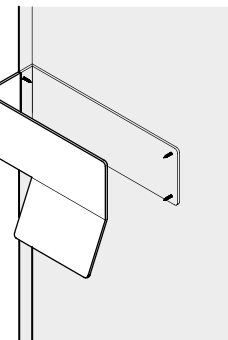
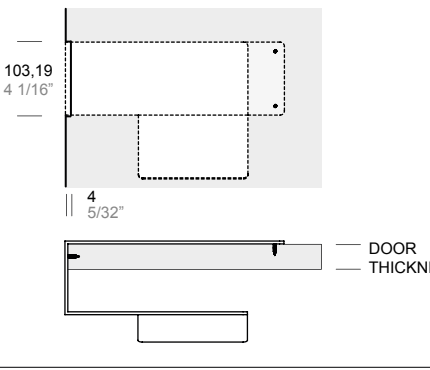
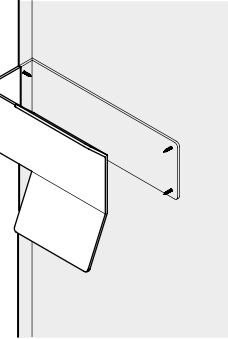
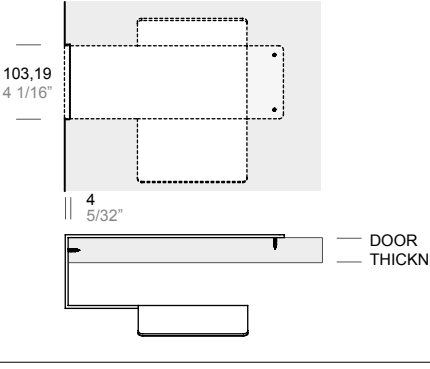
ITEM	WOOD DOOR PREPARATION DETAIL		FIXING KIT FOR WOOD DOOR	DOOR THICKNESS
<p>Design 2.1 GHF.D02.0001. xx</p>			<p>GHF.FIX.0002. xx</p>	<p>MIN 1 3/8" (35 mm)</p> <p>MAX 1 3/4" (44,45 mm)</p> <p>WOOD DOOR ONLY</p>
<p>Design 2.2 GHF.D02.0002. xx</p>			<p>GHF.FIX.0002. xx</p>	<p>MIN 1 3/8" (35 mm)</p> <p>MAX 1 3/4" (44,45 mm)</p> <p>WOOD DOOR ONLY</p>
<p>Design 2.3 GHF.D02.0003. xx</p>			<p>GHF.FIX.0002. xx</p>	<p>MIN 1 3/8" (35 mm)</p> <p>MAX 1 3/4" (44,45 mm)</p> <p>WOOD DOOR ONLY</p>
<p>Push Plate 2MM.PLA.9999. xx</p>	<p>Custom</p>	<p>Custom</p>	<p>GHF.FIX.0002. xx</p>	

FIXING:
SATIN for .44 Satin finish - BRIGHT for .43 Bright finish - BLACK for .39 Bronze .32 Grey .40 Black finish - SATIN for .31 White .38 Champagne finish